

Product Data Sheet 4118 N/2H8P

ebmpapst

The engineer's choice



4118 N/2H8P

INDEX

1	General	3
2	Mechanics	3
2.1	General.....	3
2.2	Connections.....	3
3	Operating Data	5
3.1	Electrical Interface - Input.....	5
3.2	Electrical Operating Data	6
3.3	Electrical Interface - Output.....	7
3.4	Electrical Features.....	8
3.5	Data According ErP Directive.....	10
3.6	Aerodynamics.....	11
3.7	Sound Data.....	12
4	Environment	12
4.1	General.....	12
4.2	Climatic Requirements	12
5	Safety	13
5.1	Electrical Safety.....	13
5.2	Approval Tests	13
6	Reliability	14
6.1	General.....	14

1 General

Fan type	Fan	
Rotating direction looking at rotor	Clockwise	
Airflow direction	Air intake over struts	
Bearing system	Ball bearing	
Mounting position - shaft	Any	

2 Mechanics**2.1 General**

Width	119,0 mm	
Height	119,0 mm	
Depth	38,0 mm	
Mass	0,425 kg	
Housing material	Metal	
Impeller material	Plastic	
Max. torque when mounted across both mounting flanges Screw size	Wire outlet corner: 420 Ncm Remaining corners: 600 Ncm ISO 4762 - M4 degreased, without an additional brace and without washer	

2.2 Connections

Electrical connection	Wires	
Lead wire length	L = 310 mm	
Tolerance	+ - 10,0 mm	

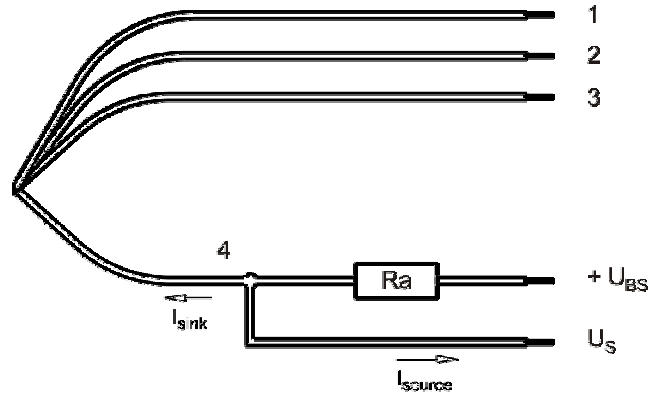

Wire	Color	Operation	Wire size	Insulation diameter
1	red	+ UB	AWG 20	2,05 mm
2	blue	- GND	AWG 20	2,05 mm
3	violet	PWM	AWG 22	1,7 mm
4	white	Tacho	AWG 22	1,7 mm

The auxiliaries shown on the schematic diagram (which are required for the intended use) are not part of our delivery.

Lead wire 1 - 2: AWG20

Lead wire 3 - 4: AWG22 (Insulation diameter 2,05mm)

3 Operating Data

3.1 Electrical Interface - Input

Control input	PWM
---------------	-----

Features

Input type	Open collector	
PWM - Frequency		1 kHz - 20 kHz

<p>Characteristics</p>	
<p>Schematics</p>	

Speed control:

PWM = 0...100 %; f = 1...20 kHz; n = 500...11.000 1/min.

Transistor requirements: VCE max. >= 12V; Isink max > 5mA; VCEsat < 0,15V

Alternatively to the PWM signal the fan can be controlled by an analog control signal of 0...5 V (5 V corresponds to 100 % PWM)

It must be ensured that the power supply is "sink-able" and can operate with the internal pull-up resistor. The shown pull-up resistor to the internal reference voltage (+5V) has 10kOhm.

3.2 Electrical Operating Data

Measurement conditions: Normal air density = 1,2 kg/m³; Temperature 23°C +/- 3°C; Motor axis horizontal; warm-up time before measuring 5 minutes (unless otherwise specified). In the intake and outlet area should not be any solid obstruction within 0,5 m.

$\Delta p = 0$: corresp. to free air flow (see chapter aerodynamics)
 I: corresp. to arithm. mean current value

Name	Condition
PWM 0001	PWM: 95 %; f: 2 kHz

Please note:

The inrush current depends on the capacitor and resistance of the lead wire. By using an external capacitor the inrush current rises.

Features	Condition	Symbol	Values		
Voltage range		U	36 V		60 V
Nominal voltage		U _N		48 V	
Power consumption	$\Delta p = 0$	P	71 W	120 W	127,0 W
Tolerance	PWM 0010		+/- 10 %	+/- 10 %	+/- 10 %
Current consumption	$\Delta p = 0$	I	2.000 mA	2.500 mA	2.100 mA
Tolerance	PWM 0010		+/- 10 %	+/- 10 %	+/- 10 %
Speed	$\Delta p = 0$	n	9.100 1/min	11.000 1/min	11.000 1/min
Tolerance	PWM 0010		+/- 7,5 %	+/- 7,5 %	+/- 7,5 %

3.3 Electrical Interface - Output

Tacho type	/2 (open collector)
------------	---------------------

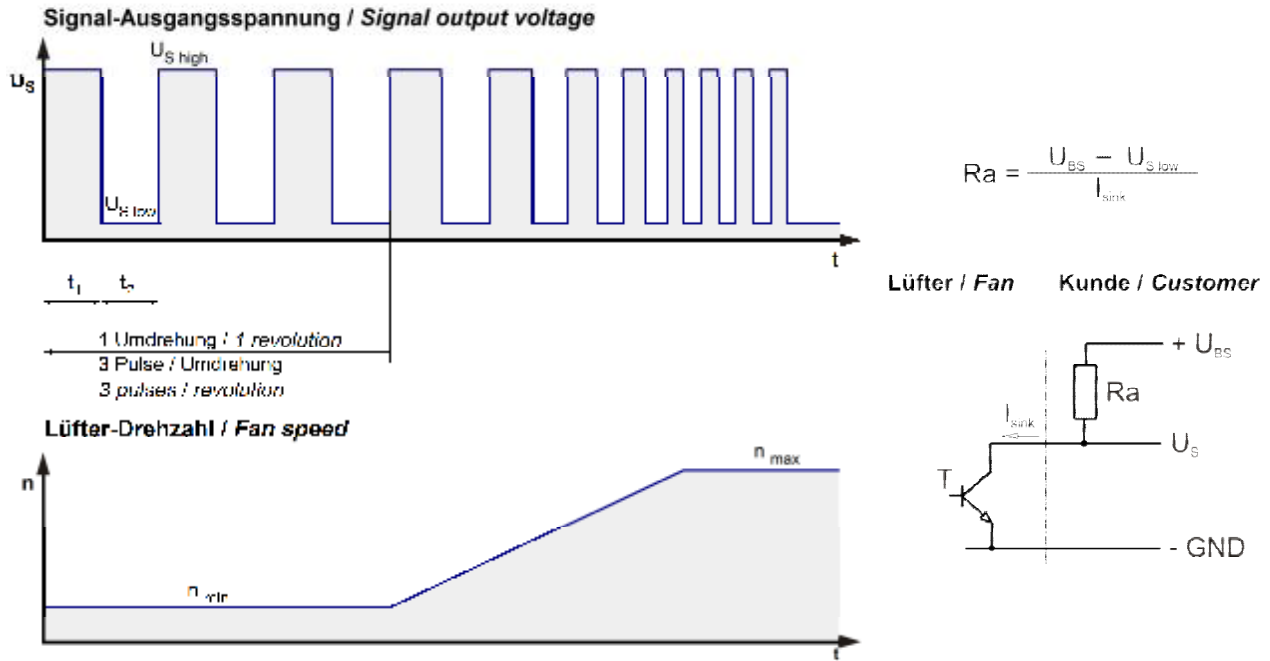

Features	Note	Values
Tacho operating voltage	U_{BS}	$\leq 60,0\ V$
Tacho signal Low	$U_{S\ low}$	$I_{sink}: 2\ mA$ $\leq 0,4\ V$
Tacho signal High	$U_{S\ high}$	$I_{source}: 0\ mA$ $\leq 60,0\ V$
Maximum sink current	I_{sink}	$\leq 20\ mA$
External resistor	External resistor R_a from U_{BS} to U_S required. All voltages measured to GND.	
Tacho frequency	$(3 \times n) / 60$	
Tacho isolated from motor	No	
Slew rate		$\Rightarrow 0,5\ V/\mu s$

n = revolutions per minute (1/min)

Note to the tacho frequency: 3 pulses per revolution.

When the fan starts up or the rotor is locked the tacho is off. After a successful start-up the tacho output signal turns on.

3.4 Electrical Features

Electronic function	Speed-Controlled	
Reversed polarity protection	N-CH FET	
Max. residual current at U_N	$I_F \leq 1 \text{ mA}$	
Locked rotor protection	Auto restart	
Locked rotor current at U_N	I_{block} approx. 2.000 mA	
Clock signal at locked rotor	t_3 / t_4 typical: 1,7 s / 5,2 s	

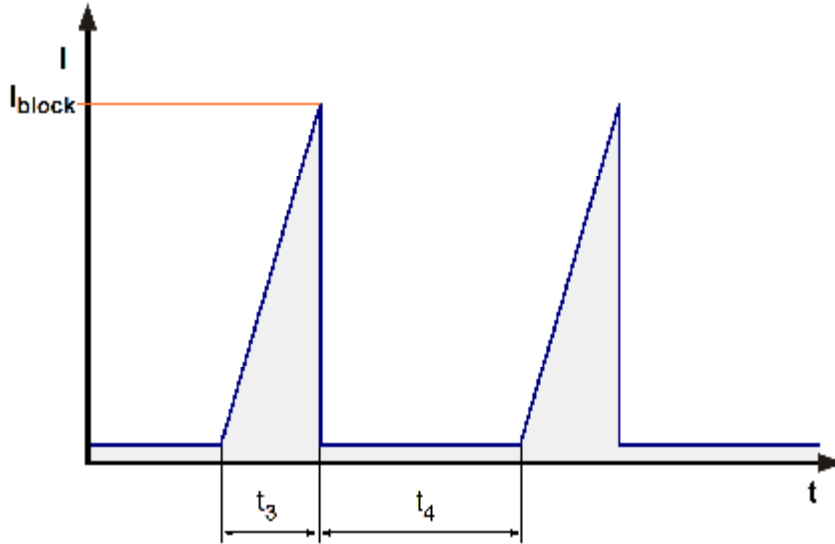

After 5 failed start-ups there is an extended timeout of 30 s.

When several fans are operated together (in a fan tray) and one fan starts after the other and the starting current is eventually limited, it can happen that the not yet operated fan is driven in reverse by the counter pressure. This can lead to a failure of the first start-up. The fan detects this and makes another start with an increased current.

The locked rotor current is denoted as peak-current at nominal voltage.

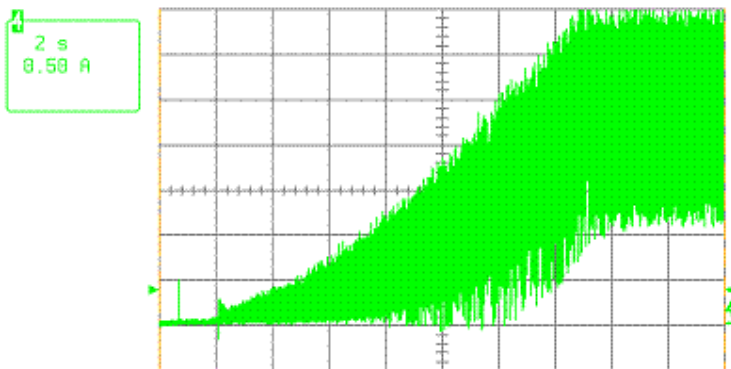

Start-up current @ 48 V, 0 - 11.000 1/min

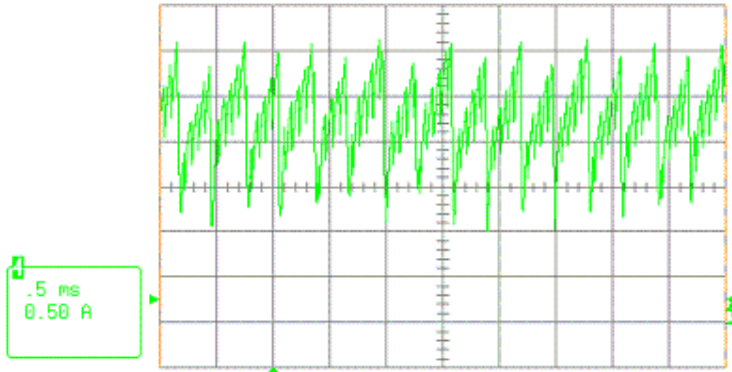

Typical running current @ 48 V, free blowing, 11.000 1/min

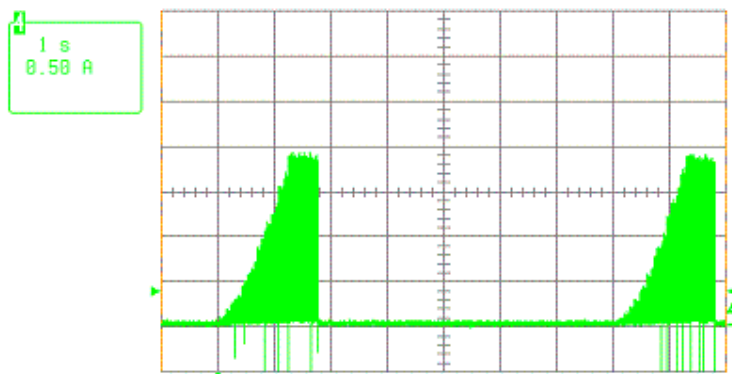

Locked rotor current @ 48 V

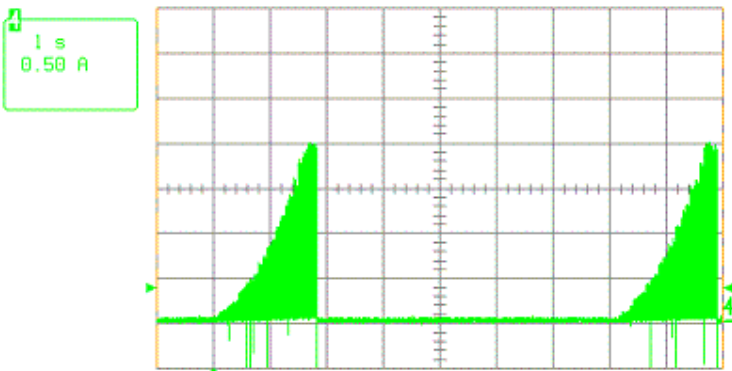

Locked rotor current @ 36 V

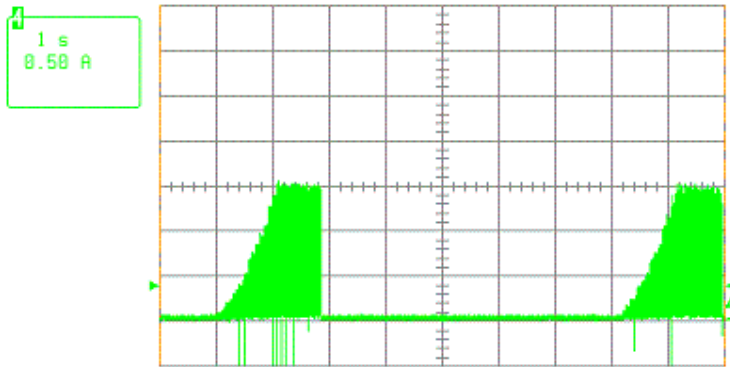

Locked rotor current @ 60 V

Internal fuse:

Littelfuse Nano2 Fuse
 Very Fast-Acting 451/453 Series
 6,3A / 125V (045106.3MRL)

3.5 Data According ErP Directive

Installation / Efficiency category	A / static
Speed control	integrated
Specific ratio	1,00524
Target overall efficiency 2015	28,4 %
Overall efficiency	40,1 %
Efficiency grade	40
Power input	143,7 W
Speed	11.060 1/min

All values measured in optimum energy efficiency point.

Productiondatecode is printed on the fan label.

3.6 Aerodynamics

Measurement conditions: Measured with a double chamber intake rig acc. to DIN EN ISO 5801.
 Normal air density = 1,2 kg/m³; Temperature 23°C +/- 3°C;
 In the intake and outlet area should not be any solid obstruction within 0,5 m. Motor shaft horizontal.
 The information is only valid under the specified test conditions and may be changed by the installation conditions. If there are deviations from the standard test conditions, the characteristic values must be checked under the installed conditions.

a.) Operation condition:

11.000 1/min at free air flow	PWM 95 %; f: 2 kHz		
-------------------------------	--------------------	--	--

Max. free-air flow ($\Delta p = 0 / \dot{V} = \text{max.}$)	565 m ³ /h	
Max. static pressure ($\Delta p = \text{max.} / \dot{V} = 0$)	1.490 Pa	

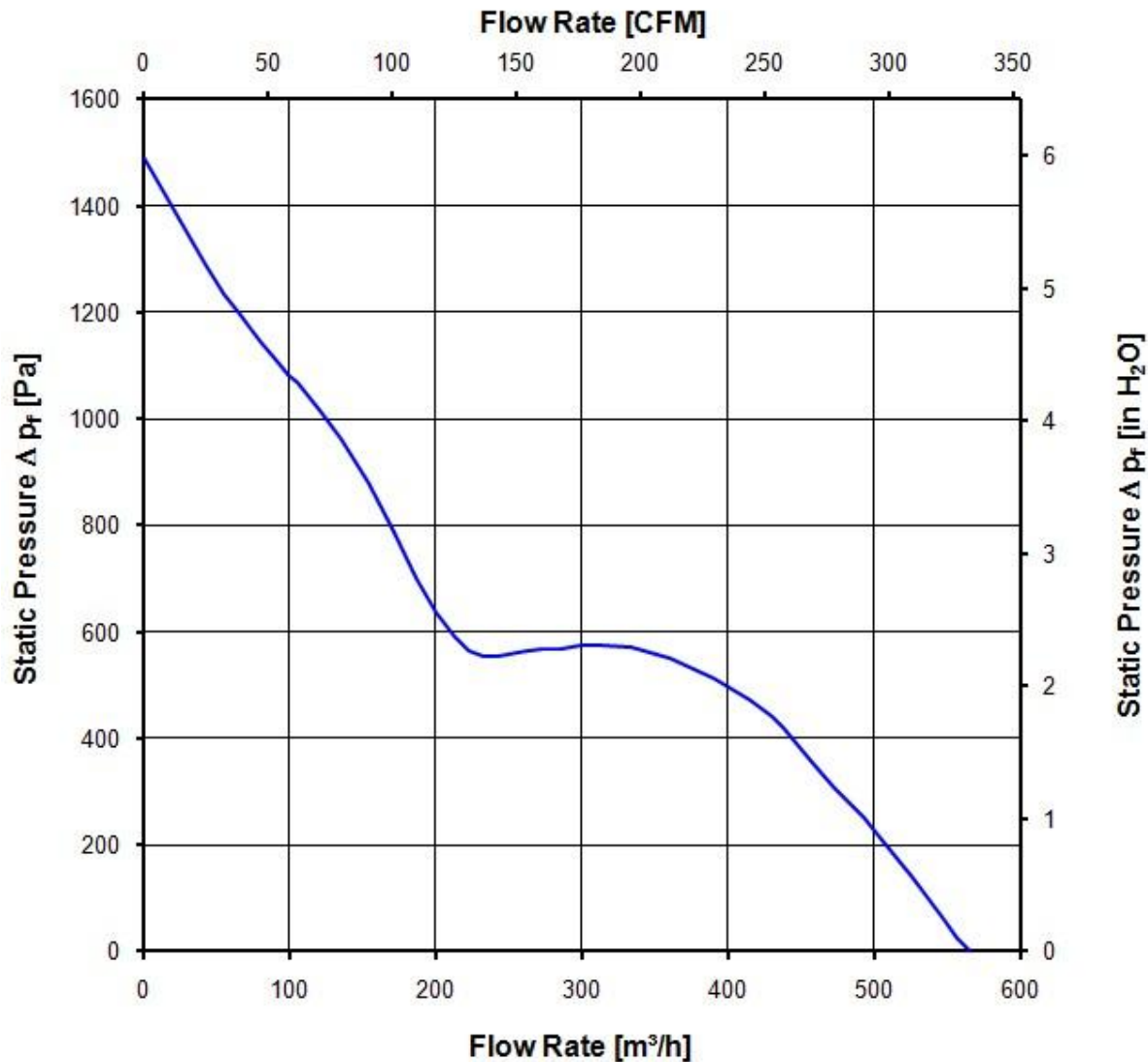

3.7 Sound Data

Measurement conditions: Sound pressure level: 1 meter distance between microphone and the air intake.
 Sound power level: Acc. to DIN 45635 part 38 (ISO 10302)
 Measured in a semianchoic chamber with a background noise level of $L_p(A) < 5 \text{ dB(A)}$
 For further measurement conditions see chapter aerodynamics.

a.) Operation condition:

11.000 1/min at free air flow	PWM 95 %; f: 2 kHz		
Optimal operating point	390 m ³ /h @ 485 Pa		
Sound power level at the optimal operating point	8,8 bel(A)		
Sound pressure level at free air flow, measured in rubber bands	79,0 dB(A)		

4 Environment

4.1 General

Min. permitted ambient temperature TU min.	-20 °C	
Max. permitted ambient temperature TU max.	75 °C	
Min. permitted storage temperature TL min.	-40 °C	
Max. permitted storage temperature TL max.	80 °C	

4.2 Climatic Requirements

Humidity requirements	humid heat, constant; according to DIN EN 60068-2-78, 14 days	
Water exposure	None	
Dust requirements	None	
Salt fog requirements	None	

Permitted application area:

The product is intended for use in sheltered rooms with controlled temperature and controlled humidity. Directly exposure to water must be avoided.

Pollution degree 1 (according DIN EN 60664-1)

There is either no pollution or it occurs only dry, non-conductive pollution. The pollution has no negative impact.

Please require severity levels and specification parameters from the responsible development departments.

5 Safety

5.1 Electrical Safety

Dielectric strength DIN EN 60950 (VDE 0805) and DIN EN 60335 (VDE 0700) A.) Type test Measuring conditions: After 48h of storage at 95% R.H. and 25°C. No arcing or breakdown is allowed! All connections together to ground. B.) Routine test Measuring conditions: At indoor climate. No arcing or breakdown is allowed! All connections together to ground.	500 VAC / 1 Min. 850 VDC / 1 Sec.	
Isolation resistance Measuring conditions: After 48h of storage at 95% R.H. and 25°C measured with U=500 VDC for 1 min.	RI > 10 MOhm	
Clearance / creepage distance	1,0 mm / 1,5 mm	
Protection class	III	

5.2 Approval Tests

CE	EC Declaration of Conformity	No
EAC	Eurasian Conformity	Yes
UL	Underwriters Laboratories	Yes / UL507, Electric Fans
VDE	Association for Electrical, Electronic and Information Technologies	Yes / Approval acc. to EN 60950 (VDE 0805) - Information technology equipment
CSA	Canadian Standards Association	Yes / C22.2 No. 113 Fans and Ventilators
CCC	China Compulsory Certification	Yes / GB 12350 Safety Requirements for small Power Motors

The approval tests are observed to:

U approval max.:60,0 V @ TU approval max.: 75,0 °C

6 Reliability

6.1 General

Attention!

In order to achieve the specified life time figure, it is necessary to connect an external capacitor.

Complexity, connection, components and configuration must be checked at the project.

As a basis a capacitor of 220...1000 uF to the supply voltage between plus and minus can be used. Max. lead length between fan and capacitor: 300 mm.

Life expectancy L10 at TU = 40 °C	55.000 h	
Life expectancy L10 at TU max.	22.500 h	
Life expectancy L10 acc. to IPC 9591 at TU = 40 °C	92.500 h	

Copyright of this document, and details of changes and the use or communication of the contents thereof, are reserved without express authority. Offenders are liable to the payment of damages. All rights are reserved in the event of the print or a partial or the reproduction of a utility model or design.

Schützenwerk nach DIN EN ISO 9001
 Refer to production notice PN 300 8000 1

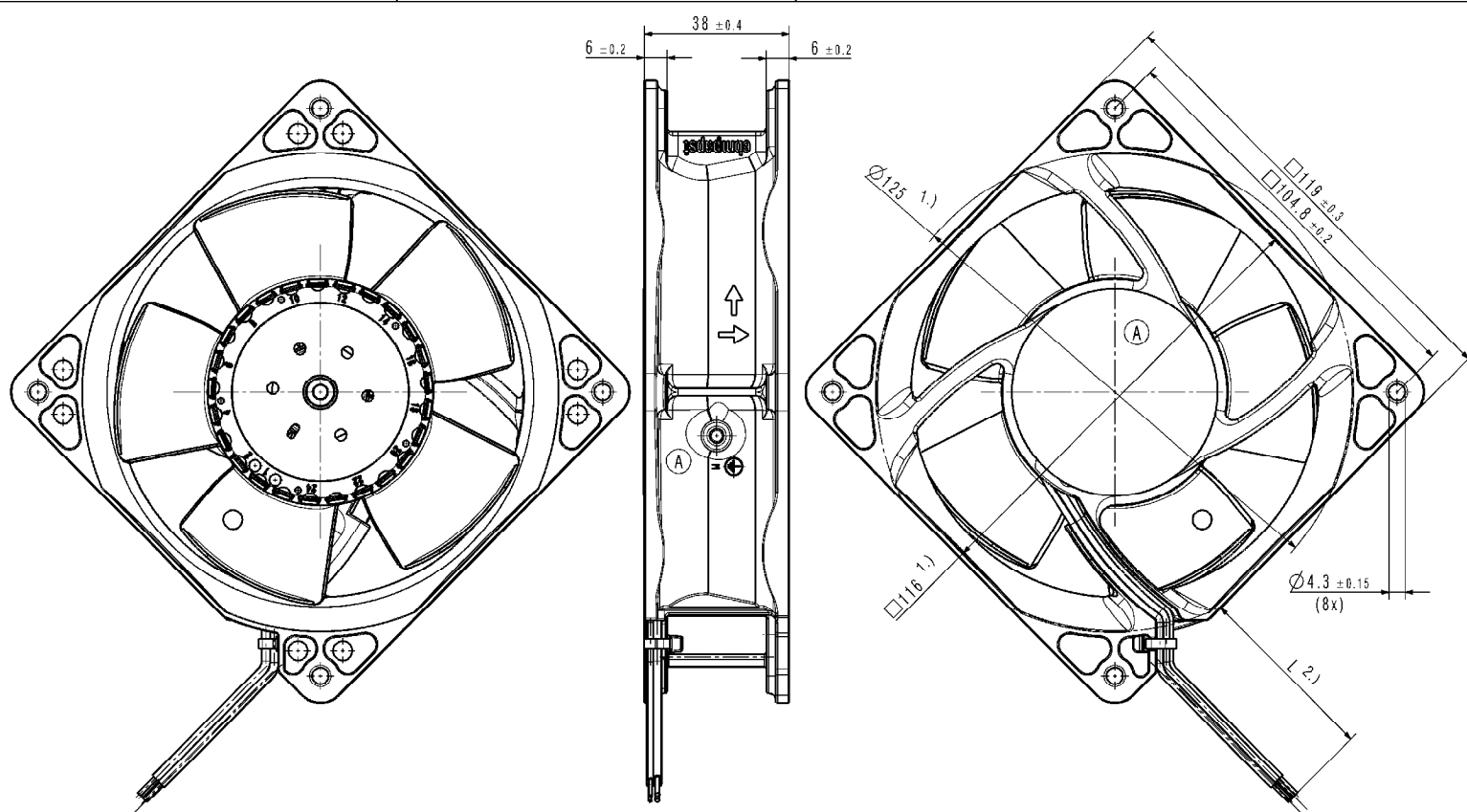

- 1.) Maße für Montageausschnitt
- 2.) Anzahl und Länge der Litzen siehe BV - Blatt 1
 - Axialspiel der Kugellager mit Feder spielfrei verspannt

- 1.) measures for mounting cut-out
- 2.) length and number of wires see design specification page 1
 - ball bearing without axial clearance by a pre-loaded spring

DW-Status/Status		Änd.-Nr./ Change No.	DATA-System-Version/ DATA-System-Version	GD-Übersicht/ GD-Environment	Werkstoff / Material:	Volumen / Volume (cm³):	
Datum		Name		Artikel / Title:		Gewicht / Mass (kg):	
Tolerierung / Tolerances:		Bauh./ Drawn:		Zug.-Nr. / Drawing No.:		Ers.f.Zug. / Replaces:	
Allgemeintoleranzen / Gen. Tolerances:		Begr./ Checked:		Schwermetalle / Type of Substance:		Format / Size:	
		Prüfung/ Revised:		Index / Index:		Maßstab/Scale:	
				eiber-papst St.Georgen GmbH & Co KG			