

Product Data Sheet 4656 ZH

ebmpapst

The engineer's choice



4656 ZH

INDEX

1 General 3

2 Mechanics 3

 2.1 GENERAL..... 3

 2.2 CONNECTIONS 4

3 Operating Data..... 5

 3.1 ELECTRICAL OPERATING DATA 5

 3.2 ELECTRICAL INTERFACE - OUTPUT 5

 3.3 ELECTRICAL FEATURES 6

 3.4 AERODYNAMICS 6

 3.5 SOUND DATA 7

4 Environment..... 7

 4.1 GENERAL..... 7

 4.2 CLIMATIC REQUIREMENTS*)..... 7

5 Safety 8

 5.1 ELECTRICAL SAFETY 8

 5.2 APPROVAL TESTS 9

6 Reliability..... 9

 6.1 GENERAL..... 9

1 General

Fan type	Fan
Rotating direction looking at rotor	Clockwise
Airflow direction	Air outlet over struts
Bearing system	Ball bearing
Mounting position - shaft	Any
Balancing grade	2,5

2 Mechanics**2.1 General**

Width	119,0 mm	
Height	119,0 mm	
Depth	38,0 mm	
Diameter	0,0 mm	
Mass	0,540 kg	
Housing material	Metal	
Impeller material	Metal	
Max. torque when mounted across both mounting flanges	Wire outlet corner: 120 Ncm Remaining corners: 350 Ncm	
Screw size	ISO 4762 - M4 degreased, without an additional brace and without washer	

2.2 Connections

Electrical connection	Plug	
Lead wire length	L = 310,0 mm	
Tolerance	+/- 10,0 mm	
Tube length	See drawing	
Tolerance		
Wire size (AWG)	22	
Insulation diameter	1,20 mm	
Plug	See drawing	
Contact	See drawing	

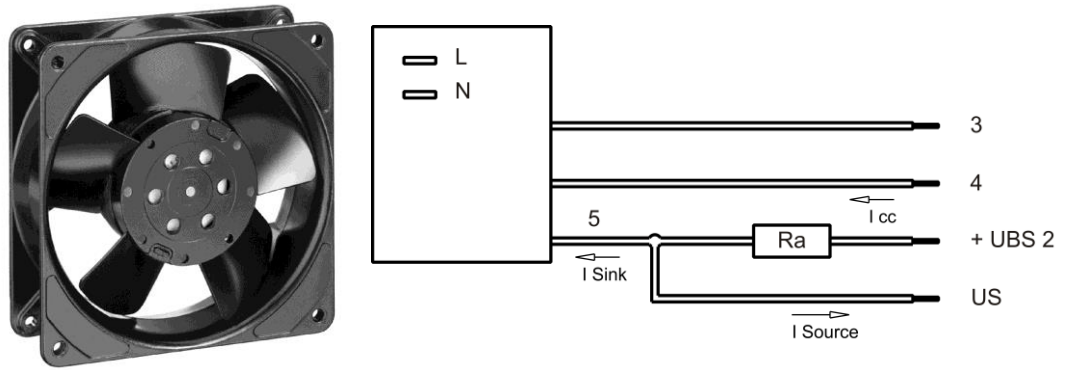

	Color	Operation
3	violet	- GND Tacho
4	red	+ UB Tacho
5	white	Tacho

The auxiliaries shown on the schematic diagram (which are required for the intended use) are not part of our delivery.

3 Operating Data

3.1 Electrical Operating Data

Measurement conditions: Normal air density = 1,2 kg/m³; Temperature 23°C +/- 3°C; Motor axis horizontal; warm-up time before measuring 5 minutes (unless otherwise specified).
In the intake and outlet area should not be any solid obstruction within 0,5 m.

$\Delta p = 0$: corresp. to free air flow (see chapter aerodynamics)
I: corresp. to RMS line current

Features	Condition	Symbol	Values	
Frequency	$\Delta p = 0$	f	50 Hz	60 Hz
Nominal voltage	$\Delta p = 0$	U_N	230 V	230 V
Tolerance			+ 6 % - 10 %	+ 6 % - 10 %
Power consumption	$\Delta p = 0$	P	19 W	18 W
Tolerance			+/- 10 %	+/- 10 %
Speed	$\Delta p = 0$	n	2.650 1/min	3.100 1/min
Tolerance			+/- 3 %	+/- 3 %

3.2 Electrical Interface - Output

Tacho type	Special-Tacho
------------	---------------

Signal-Ausgangsspannung / Signal output voltage

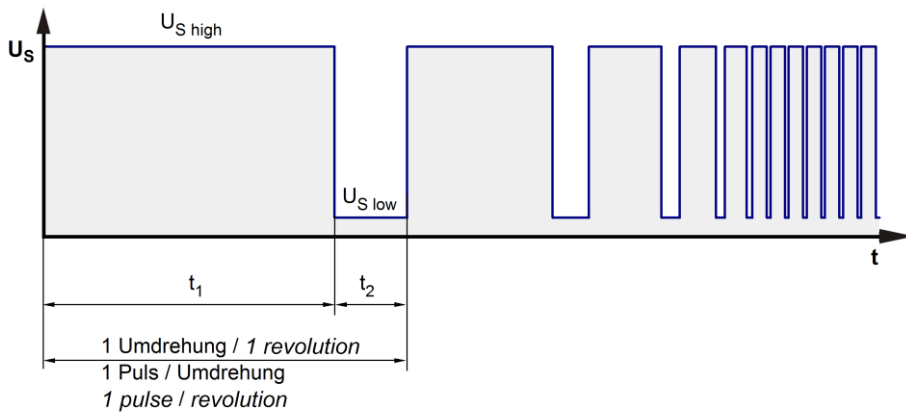

Lüfter-Drehzahl / Fan speed

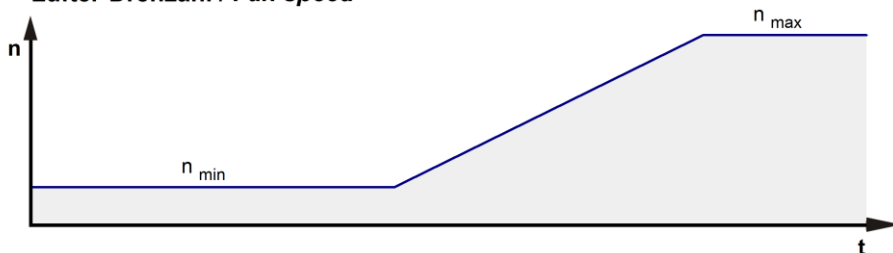

Features	Note	Values
Tacho operating voltage		4,5... 24 V
Tacho operating current (I cc at max. UBS 1)		<= 10 mA
Tacho nominal voltage (UBS 2)		< 30 VDC
Tacho signal Low	I sink: 15 mA	<= 0,4 V
Tacho signal High	I source: 0 mA	30 V
Maximum sink current		<= 20 mA
tacho pulse time		Min: 0,28 s Max.: 1,5 s
External resistor	External resistor Ra from UBS to US required. All voltages measured to GND.	
Tacho frequency	n/50	
Tacho isolated from motor	Yes	

3.3 Electrical Features

Locked rotor protection	Impedance
Locked rotor current at	

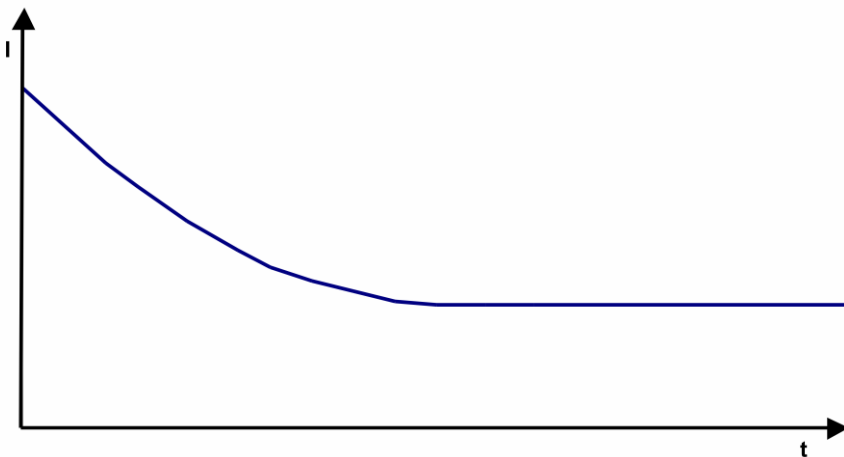

3.4 Aerodynamics

Measurement conditions: Measured with a double chamber intake rig acc. to DIN EN ISO 5801. Normal air density = 1,2 kg/m³; Temperature 23°C +/- 3°C; In the intake and outlet area should not be any solid obstruction within 0,5 m. Motor shaft horizontal. The information is only valid under the specified test conditions and may be changed by the installation conditions. If there are deviations from the standard test conditions, the characteristic values must be checked under the installed conditions.

a.) Operation condition: 2.650 1/min at free air flow Frequency: 50 Hz

Max. free-air flow ($\Delta p = 0 / \dot{V} = \text{max.}$)	152,0 m ³ /h
Max. static pressure ($\Delta p = \text{max.} / \dot{V} = 0$)	70 Pa

b.) Operation condition: 3.100 1/min at free air flow Frequency: 60 Hz

Max. free-air flow ($\Delta p = 0 / \dot{V} = \text{max.}$)	180,0 m ³ /h
Max. static pressure ($\Delta p = \text{max.} / \dot{V} = 0$)	80 Pa

3.5 Sound Data

Measurement conditions: Sound pressure level: 1 meter distance between microphone and the air intake.
 Sound power level: Acc. to DIN 45635 part 38 (ISO 10302) Sound power level: Acc. to DIN 45635 part 38 (ISO 10302)
 Measured in a semianchoic chamber with a background noise level of $L_p(A) < 5 \text{ dB}(A)$
 For further measurement conditions see chapter aerodynamics.

a.) Operation condition:
 2.650 1/min at free air flow Frequency: 50 Hz

Optimal operating point	130,0 m ³ /h @ 15 Pa	
Sound power level at the optimal operating point	5,1 bel(A)	
Sound pressure level at free air flow, measured in rubber bands	37,0 dB(A)	

b.) Operation condition:
 3.100 1/min at free air flow Frequency: 60 Hz

Optimal operating point	148,0 m ³ /h @ 20 Pa	
Sound power level at the optimal operating point	5,5 bel(A)	
Sound pressure level at free air flow, measured in rubber bands	42,0 dB(A)	

4 Environment

4.1 General

Min. permitted ambient temperature TU min.	-40 °C / 50 Hz -40 °C / 60 Hz	
Max. permitted ambient temperature TU max.	75 °C / 50 Hz 85 °C / 60 Hz	
Min. permitted storage temperature TL min.	-40 °C	
Max. permitted storage temperature TL max.	100 °C	

4.2 Climatic Requirements *)

Humidity requirements	humid heat, constant; according to DIN EN 60068-2-78, 14 days	
Water exposure	None	
Dust requirements	None	
Salt fog requirements	None	

Permitted application area:
 The product is intended for use in sheltered rooms with controlled temperature and controlled humidity. Directly exposure to water must be avoided.

Pollution degree 1 (according DIN EN 60664-1)

There is either no pollution or it occurs only dry, non-conductive pollution. The pollution has no negative impact.

5 Safety

5.1 Electrical Safety

Dielectric strength DIN EN 60950 (VDE 0805) and DIN EN 60335 (VDE 0700) A.) Type test (Motor to ground U1) Measuring conditions: After 48 h of storage at 95% r. h. and 25°C. No arcing or breakdown is allowed! All motor connections together to ground! B.) Routine test (Motor to ground U1) Measuring conditions: At indoor climate. No arcing or breakdown is allowed! All motor connections together to ground!	1500 VAC / 1 Min. 1500 VAC / 1 Sec.
Insulation resistance (Motor to ground U1) Measuring conditions: After 48 h of storage at 95% r. h. and 25°C measured with U = 500 VDC for 1 min.	RI > 10 MOhm
C.) Type test (Tacho to ground U2) Measuring conditions: After 48 h of storage at 95% r. h. and 25°C. No arcing or breakdown is allowed! All tacho connections together to ground! D.) Routine test (Tacho to ground U2) Measuring conditions: At indoor climate. No arcing or breakdown is allowed! All tacho connections together to ground!	500 VAC / 1 Min. 600 VAC / 1 Sec.
E.) Type test (Tacho to Motor U3) Measuring conditions: After 48 h of storage at 95% r. h. and 25°C. No arcing or breakdown is allowed! All tacho connections together to all motor connections! F.) Routine test (Tacho to Motor U3) Measuring conditions: At indoor climate. No arcing or breakdown is allowed! All tacho connections together to all motor connections!	3750 VAC / 1 Min. 4200 VAC / 1 Sec.
Insulation resistance (Tacho to Motor U3) Measuring conditions: After 48 h of storage at 95% r. h. and 25°C measured with U = 1000 VDC for 1 min.	RI > 20 MOhm
Clearance / creepage distance	2,0 mm / 1,8 mm
Protection class	I

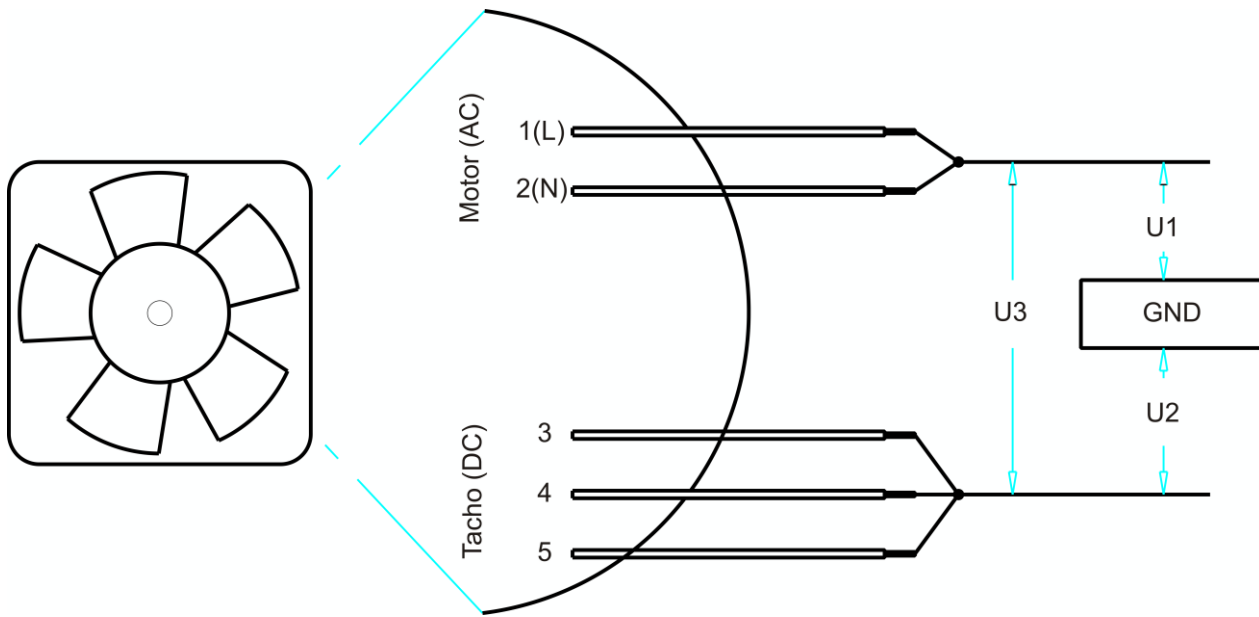

5.2 Approval Tests

CE	EC Declaration of Conformity	Yes
EAC	Eurasian Conformity	Yes
UL	Underwriters Laboratories	Yes / UL507, Electric Fans
VDE	Association for Electrical, Electronic and Information Technologies	Yes / Approval acc. to EN 60950 (VDE 0805) - Information technology equipment
CSA	Canadian Standards Association	Yes / C22.2 No. 113 Fans and Ventilators
CCC	China Compulsory Certification	Yes / GB 12350 Safety Requirements for small Power Motors

The approval tests are observed to:

U approval max.: 230 V / f: 60 Hz @ TU approval max.: 85 °C

6 Reliability

6.1 General

Life expectancy L10 at TU = 40 °C	37.500 h / 50 Hz 40.000 h / 60 Hz	
Life expectancy L10 at TU max.	17.500 h / 50 Hz 15.000 h / 60 Hz	

Layout of the flanges and pins to wires and the connection of the earth cable must be in the same position as in the drawing of a product or the manufacturer's official manual in German.

Schaltzweck nach DIN EN 60439 beachten
Refer to position within EN 60439

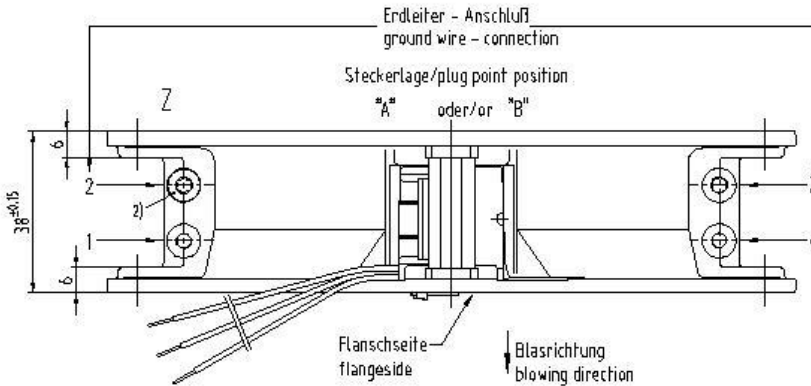
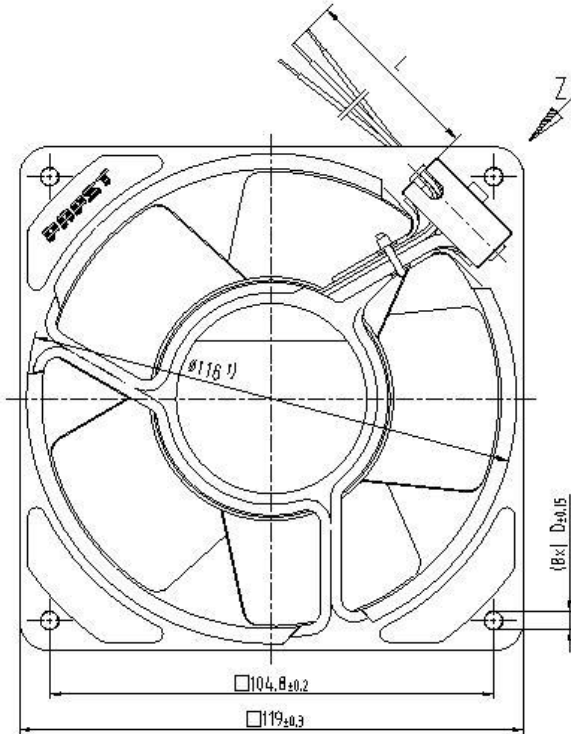

Erzeugnis-Nr. product number	Typ	Lagersystem bearing system	Befestigungs- bohrung - # D mounting holes # D	Steckermaß plug dimension B/C	Steckerlage plug position	Lage des Erdleiter- Anschlusses Position the ground wire connection	Litzenlänge Wire length L
924 4014 870	9858 ZH	K	4,3	0,5/8,5	"A"	2	310 ± 10
924 4014 876	4606 ZH	K	4,3	0,5/8,5	"A"	2	310 ± 10
924 4014 888	4588 ZH-888	K	4,3	0,5/8,5	"A"	2	420 ± 10
924 4014 968	4600 ZH	G	4,3	0,5/8,5	"A"	2	310 ± 10
924 4014 010	4538 ZH-010	K	4,3	0,5/8,5	"A"	2	950 ± 10

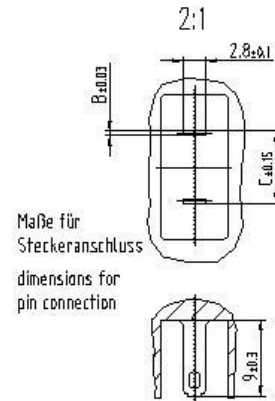

- 1) Maße für Montagewand
2) Schraube: Duo-Tapfite nach DIN 7500,
CM 4x8, Torx

- 1) dimensions for assembly wall
2) Screw: Duo-Tapfite to DIN 7500,
CM 4x8, Torx

- Axialspiel bei
- Kugellagerung (K): 0 (mit Federausgleich)
- Gleitlagerung (G): 0.1 - 0.6
- Gleitlagerung (GF): 0 (mit Federausgleich)

- axial clearance by
- ball bearing (K): 0 (with spring compensation)
- sleeve bearing (G): 0.1 - 0.6
- sleeve bearing (GF): 0 (with spring compensation)

SNr/Serial/Date	Part-Nr./Change-No.	Artik.-No./Serial-Vermerk Edm/Edm	ebmpapst COB-Änderung/ COB-Environment	Werkstoff/Material:	Volumen/Volume (mm³)	
		Bearb./ Date	Name/Name	Artikel/Title	Gewicht/Weight (g)	
Toleranz/Tolerance:		Bearb./ Date				
Allgemeintoleranz/Gen. tolerances				Zug-Nr./Drawing-No.	Erst-Zug/Replaces	
		Edm-Änderung/Type of Change	Feldnummer/Block-Point	Individuell	Form/Size	Hersteller/Make
		ebm-papst St. Georgen GmbH & Co. KG				