

Product Data Sheet RER225-55/18/2TDO

ebmpapst

The engineer's choice



RER225-55/18/2TDO

INDEX

1	General	3
2	Mechanics	3
2.1	General.....	3
2.2	Connections.....	3
3	Operating Data	5
3.1	Electrical Interface - Input.....	5
3.2	Electrical Operating Data	7
3.3	Electrical Interface - Output.....	8
3.4	Electrical Features	8
3.5	Data According ErP Directive	9
3.6	Aerodynamics.....	10
3.7	Sound Data.....	12
4	Environment	12
4.1	General.....	12
4.2	Climatic Requirements	12
5	Safety	13
5.1	Electrical Safety	13
5.2	Approval Tests.....	13
6	Reliability	13
6.1	General.....	13

1 General

Fan type	Blower without chassis with intake nozzle	
Rotating direction looking at rotor	Clockwise	
Airflow direction	Air in axially, Air out radially	
Bearing system	Ball bearing	
Mounting position - shaft	Any	

2 Mechanics**2.1 General**

Depth	99,0 mm	
Diameter	225,0 mm	
Mass	1,29 kg	
Housing material		
Impeller material	Plastic	

2.2 Connections

Electrical connection	Wires	
Lead wire length	L = 410 mm	
Tolerance	+ - 10,0 mm	
Tube length	S = 120 mm	
Tolerance	+ - 5,0 mm	

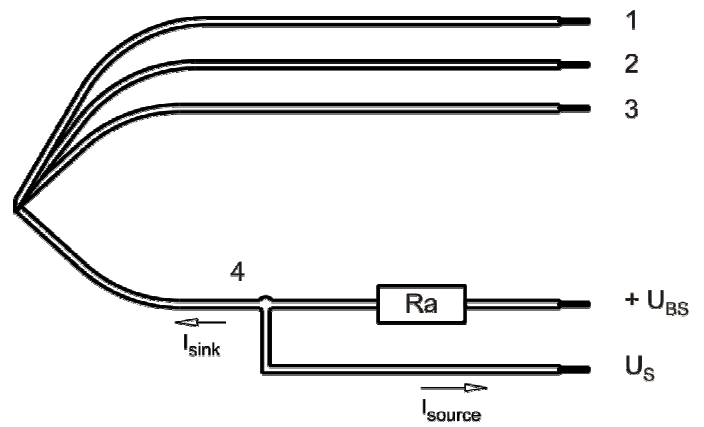

Wire	Color	Operation	Wire size	Insulation diameter
1	red	+ UB	AWG 18	2,2 mm
2	blue	- GND	AWG 18	2,2 mm
3	violet	CONTR	AWG 22	1,30 mm
4	white	Tacho	AWG 22	1,30 mm

The auxiliaries shown on the schematic diagram (which are required for the intended use) are not part of our delivery.

3 Operating Data

3.1 Electrical Interface - Input

Control input	Analog
---------------	--------

Features

PWM - Frequency	1 kHz - 10 kHz typical: 2 kHz
Input voltage range	0 V - 10 V

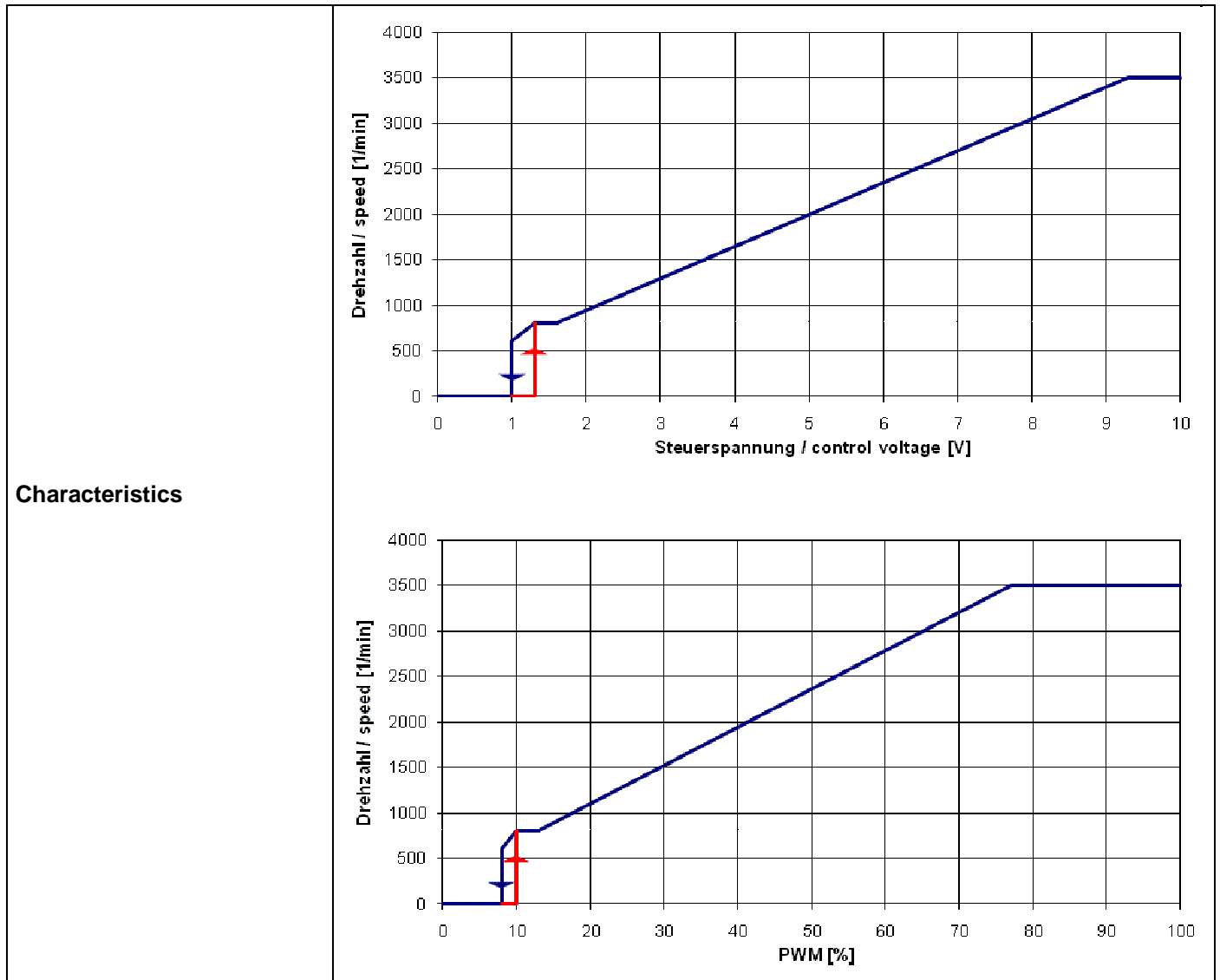

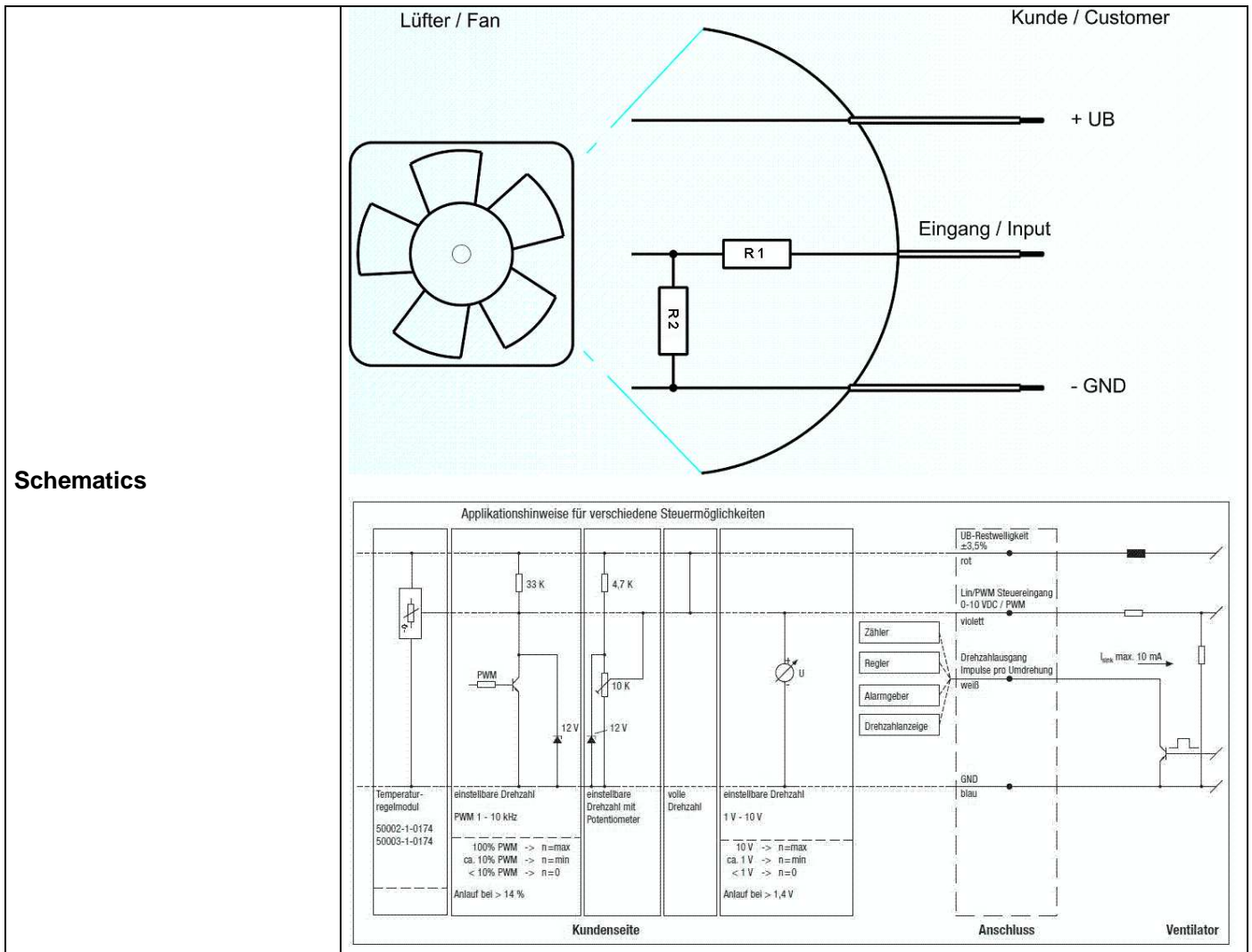

Input voltage divider:

R1 = 47 kOhm

R2 = 36 kOhm

For protection: There is parallel to R2 a 5,1 V Z-Diode

Speed control:

By pulse-width modulation (PWM) 0 ... 100%
with switching transistor in emitter circuit and collector resistance to 12 V
Frequency = 2 kHz (1 - 10 kHz)

Information to the curve PWM:

- 0% - <10% PWM: 0 1/min
- 10% PWM: 800 1/min (Fan on, coming from 0% PWM)
- 10% - 13% PWM: 800 1/min (corresponding to min. speed)
- 13% - 78% PWM: linear increasing curve
- 78% - 100% PWM: 3.500 1/min (corresponding to max. speed)
- 10% - >8% PWM: linear decreasing curve (coming from 100% PWM)
- 8% PWM: 600 1/min or 0 1/min (Fan off, coming from 100% PWM)

or:

Speed control:

By analog voltage 0 - 10 V

Information to the curve analog:

0 V - < 1,3 V:	0 1/min
1,3 V:	800 1/min (Fan on, coming from von 0 V)
1,3 V - 1,6 V:	800 1/min (corresponding to min. speed)
1,6 V - 9,4 V:	linear increasing curve
9,4 V - 10 V:	3.500 1/min (corresponding to max. speed)
1,3 V - > 1,0 V:	linear decreasing curve (coming from 10 V)
1,0 V:	600 1/min or 0 1/min (Fan off, coming from 10 V)

The fan have no sensor break detection!

3.2 Electrical Operating Data

Measurement conditions: Normal air density = 1,2 kg/m³; Temperature 23°C +/- 3°C; Motor axis horizontal; warm-up time before measuring 5 minutes (unless otherwise specified).
In the intake and outlet area should not be any solid obstruction within 0,5 m.

Measurement setup:	Measured between two steel plates
Steel plate:	266 mm x 266 mm
Intake nozzle:	D: 146 mm; R: 25 mm
Distance between bottom and top plate:	123,5 mm
Overlapping impeller / nozzle:	2 mm

$\Delta p = 0$: corresp. to free air flow (see chapter aerodynamics)

I: corresp. to arithm. mean current value

Name	Condition
U Contr. 0001	U Contr.: 10 V

The data at 5V are no FK features and need not be tested.

Features	Condition	Symbol	Values		
Voltage range		U	36 V		72 V
Nominal voltage		U _N		48 V	
Power consumption	$\Delta p = 0$	P	123 W	226 W	230 W
Tolerance	U Contr. 0010		+/- 10,0 %	+/- 10,0 %	+/- 10,0 %
Current consumption	$\Delta p = 0$	I	3.500 mA	4.700 mA	3.200 mA
Tolerance	U Contr.0010		+/- 10,0 %	+/- 10,0 %	+/- 10,0 %
Speed	$\Delta p = 0$	n	2.960 1/min	3.500 1/min	3.500 1/min
Tolerance	U Contr. 0010		+/- 7,5 %	+/- 5,0 %	+/- 5,0 %

3.3 Electrical Interface - Output

Tacho type	/2 (open collector)
------------	---------------------

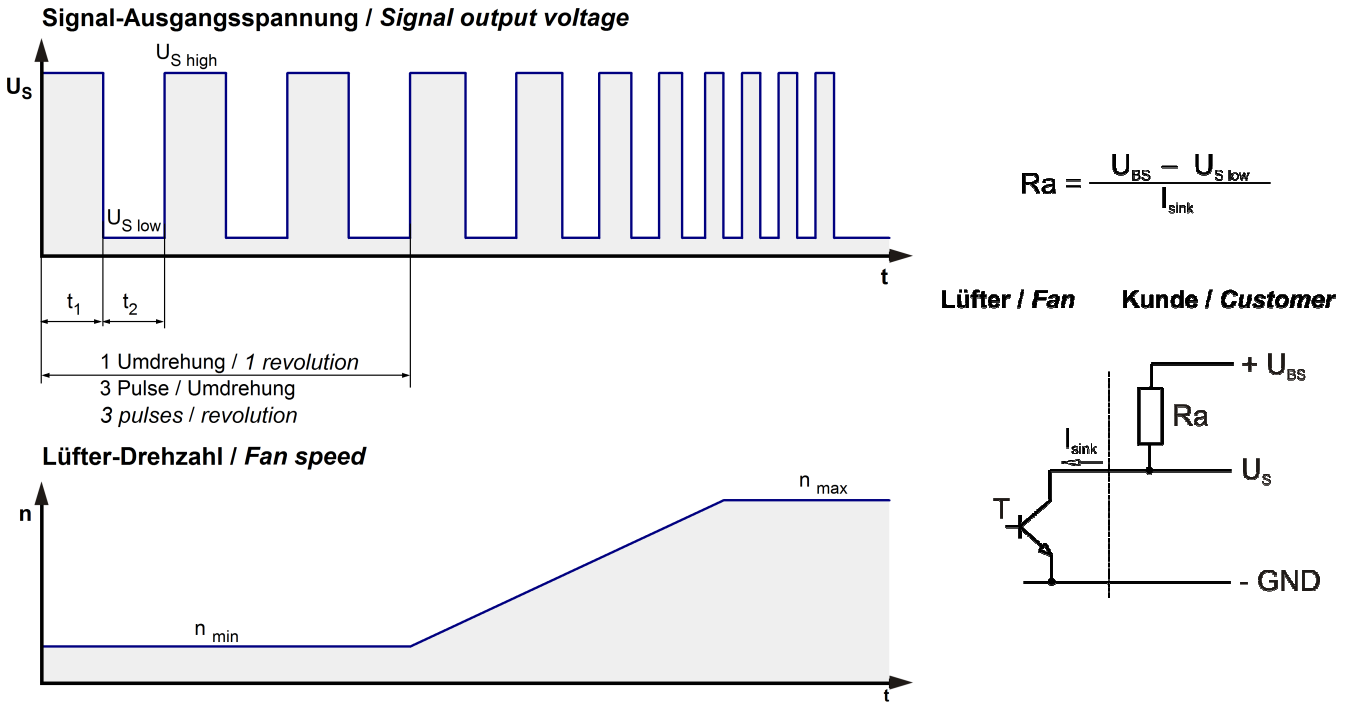

Features	Note	Values
Tacho operating voltage	U_{BS}	$\leq 60,0\ V$
Tacho signal Low	$U_{S\ low}$	$\leq 0,4\ V$
Tacho signal High	$U_{S\ high}$	$\leq 60,0\ V$
Maximum sink current	I_{sink}	$\leq 20\ mA$
External resistor	External resistor Ra from UBS to US required. All voltages measured to GND.	
Tacho frequency	$(3 \times n) / 60$	175 Hz @ 3.500 1/min
Tacho isolated from motor	No	
Slew rate		$\Rightarrow 0,5\ V/us$

n = revolutions per minute (1/min)

Please note:

At zero speed the tacho signal is at a static HIGH. It will be also HIGH when the fan is still spinning, but the speed control signal is set to zero speed already.
 The tacho signal is only activated after the start-up is completed.

3.4 Electrical Features

Electronic function	Speed-Controlled	
Reversed polarity protection	P-CH FET	
Max. residual current at U_N	$I_F \leq 5\ mA$	

Locked rotor protection	Auto restart	
Locked rotor current at U_N	I_{block} approx. 2.000 mA	
Clock signal at locked rotor	t_3 / t_4 typical: 7,2 s / 10,0 s	
Internal fuse	Littelfuse NANO2 > Very Fast-Acting > 451/453 Series 10A / 125V (Art.No.: 0451010.MRL)	

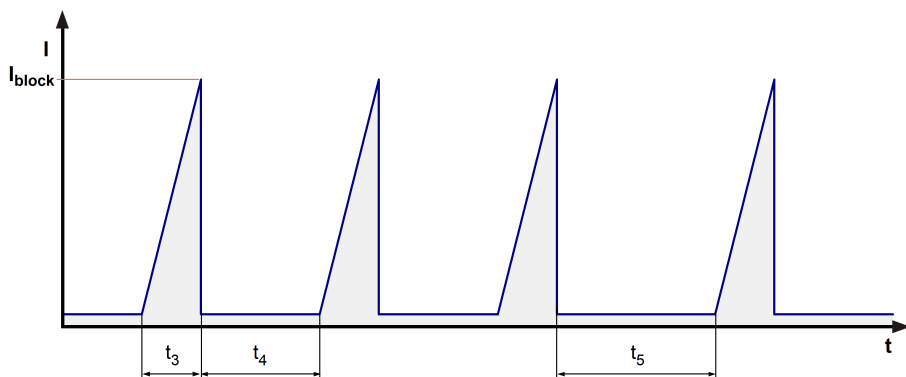

Locked rotor signal t_5 :

After 2 failed start-ups there is an extended timeout of 50 s.

3.5 Data According ErP Directive

Installation / Efficiency category	A / static
Speed control	integrated
Specific ratio	1,00640
Target overall efficiency 2015	45,6 %
Overall efficiency	59,4 %
Efficiency grade	62
Power input	273,8 W
Speed	3.450 1/min

All values measured in optimum energy efficiency point.

Productiondatecode is printed on the fan label.

3.6 Aerodynamics

Measurement conditions:

Measured with a double chamber intake rig acc. to DIN EN ISO 5801.

Normal air density = 1,2 kg/m³; Temperature 23°C +/- 3°C;

In the intake and outlet area should not be any solid obstruction within 0,5 m. Motor shaft horizontal.

The information is only valid under the specified test conditions and may be changed by the installation conditions. If there are deviations from the standard test conditions, the characteristic values must be checked under the installed conditions. Power consumption of the fan motor when operating at normal voltage is shown. Depending on the operating conditions of the application, the power input may be higher.

Measurement setup:	Measured between two steel plates
Steel plate:	266 mm x 266 mm
Intake nozzle:	D: 146 mm; R: 25 mm
Distance between bottom and top plate:	123,5 mm
Overlapping impeller / nozzle:	2 mm

a.) Operation condition:

3.500 1/min at free air flow	U Contr. 10 V		
------------------------------	---------------	--	--

Max. free-air flow ($\Delta p = 0 / \dot{V} = \text{max.}$)	1.540 m ³ /h	
Max. static pressure ($\Delta p = \text{max.} / \dot{V} = 0$)	935 Pa	

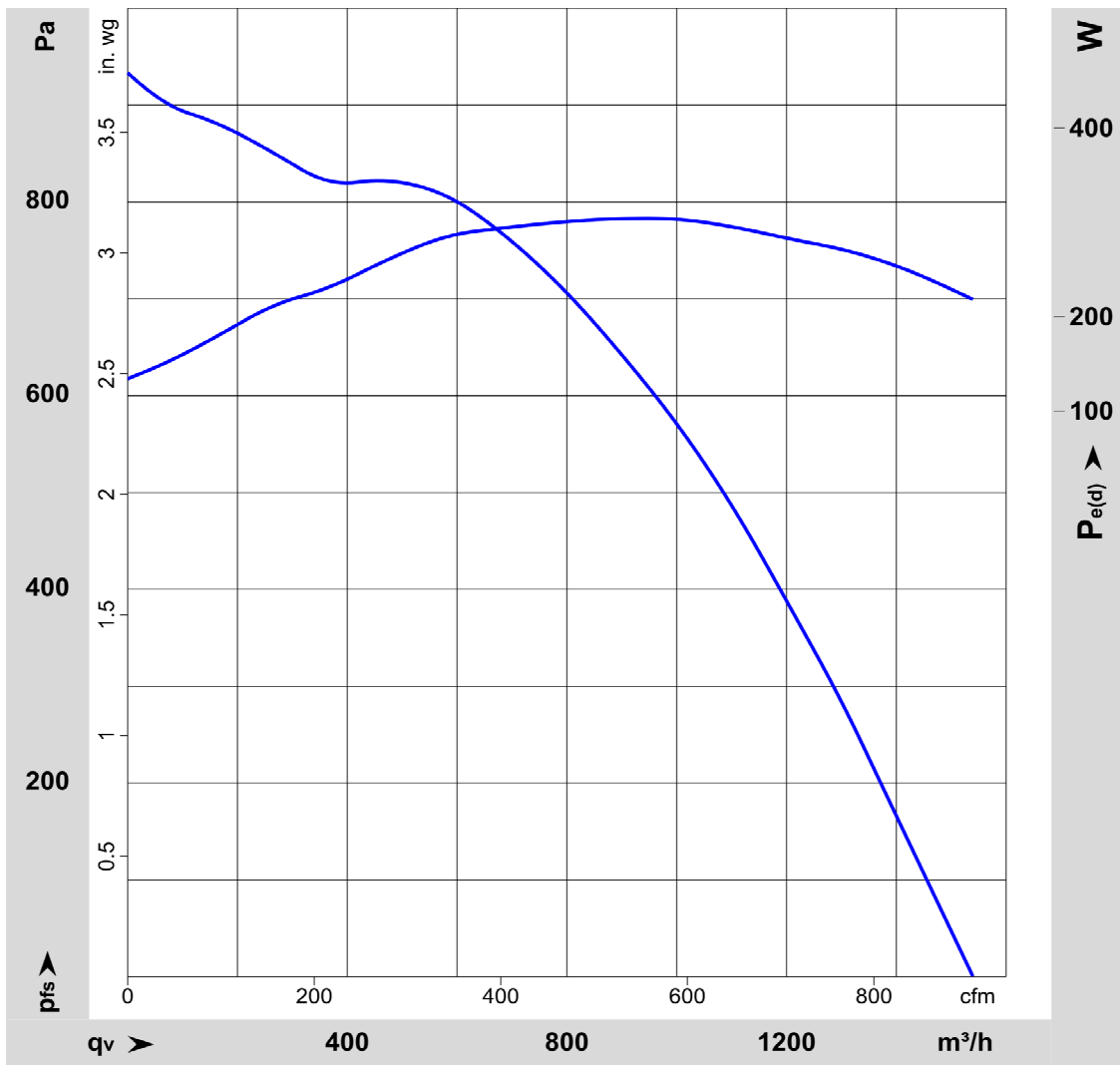

3.7 Sound Data

Measurement conditions: Sound pressure level: 1 meter distance between microphone and the air intake.
 Sound power level: Acc. to DIN 45635 part 38 (ISO 10302)
 Measured in a semianchoic chamber with a background noise level of $L_p(A) < 5 \text{ dB(A)}$
 For further measurement conditions see chapter aerodynamics.

a.) Operation condition:

3.500 1/min at free air flow	U Contr. 10 V		
------------------------------	---------------	--	--

Optimal operating point	1.002 m ³ /h @ 570 Pa	
Sound power level at the optimal operating point	8 bel(A)	
Sound pressure level at free air flow, measured in rubber bands		

4 Environment

4.1 General

Min. permitted ambient temperature TU min.	-20 °C	
Max. permitted ambient temperature TU max.	55 °C	
Min. permitted storage temperature TL min.	-40 °C	
Max. permitted storage temperature TL max.	80 °C	

4.2 Climatic Requirements

Humidity requirements	humid heat, constant; according to DIN EN 60068-2-78, 14 days	
Water exposure	None	
Dust requirements	None	
Salt fog requirements	None	

Permitted application area:

The product is intended for use in sheltered rooms with controlled temperature and controlled humidity. Directly exposure to water must be avoided.

Pollution degree 1 (according DIN EN 60664-1)

There is either no pollution or it occurs only dry, non-conductive pollution. The pollution has no negative impact.

Please require severity levels and specification parameters from the responsible development departments.

5 Safety

5.1 Electrical Safety

Dielectric strength DIN EN 60950 (VDE 0805) and DIN EN 60335 (VDE 0700) A.) Type test Measuring conditions: After 48h of storage at 95% R.H. and 25°C. No arcing or breakdown is allowed! All connections together to ground.	1000 VAC / 1 Min.	
B.) Routine test Measuring conditions: At indoor climate. No arcing or breakdown is allowed! All connections together to ground.	1700 VDC / 1 Sec.	
Isolation resistance Measuring conditions: After 48h of storage at 95% R.H. and 25°C measured with U=500 VDC for 1 min.	RI > 10 MOhm	
Clearance / creepage distance	1,0 mm / 1,5 mm	
Protection class	I	

5.2 Approval Tests

CE	EC Declaration of Conformity	Yes
EAC	Eurasian Conformity	Yes
UL	Underwriters Laboratories	Yes / UL507, Electric Fans
VDE	Association for Electrical, Electronic and Information Technologies	Yes / Approval acc. to EN 60950 (VDE 0805) - Information technology equipment
CSA	Canadian Standards Association	Yes / CSA audited by UL according to C22.2 No. 113 Fans and Ventilators
CCC	China Compulsory Certification	Yes / GB 12350 Safety Requirements for small Power Motors

6 Reliability

6.1 General

Life expectancy L10 at TU = 40 °C	50.000 h	
Life expectancy L10 at TU max.	35.000 h	
Life expectancy L10 acc. to IPC 9591 at TU = 40 °C	85.0 00 h	

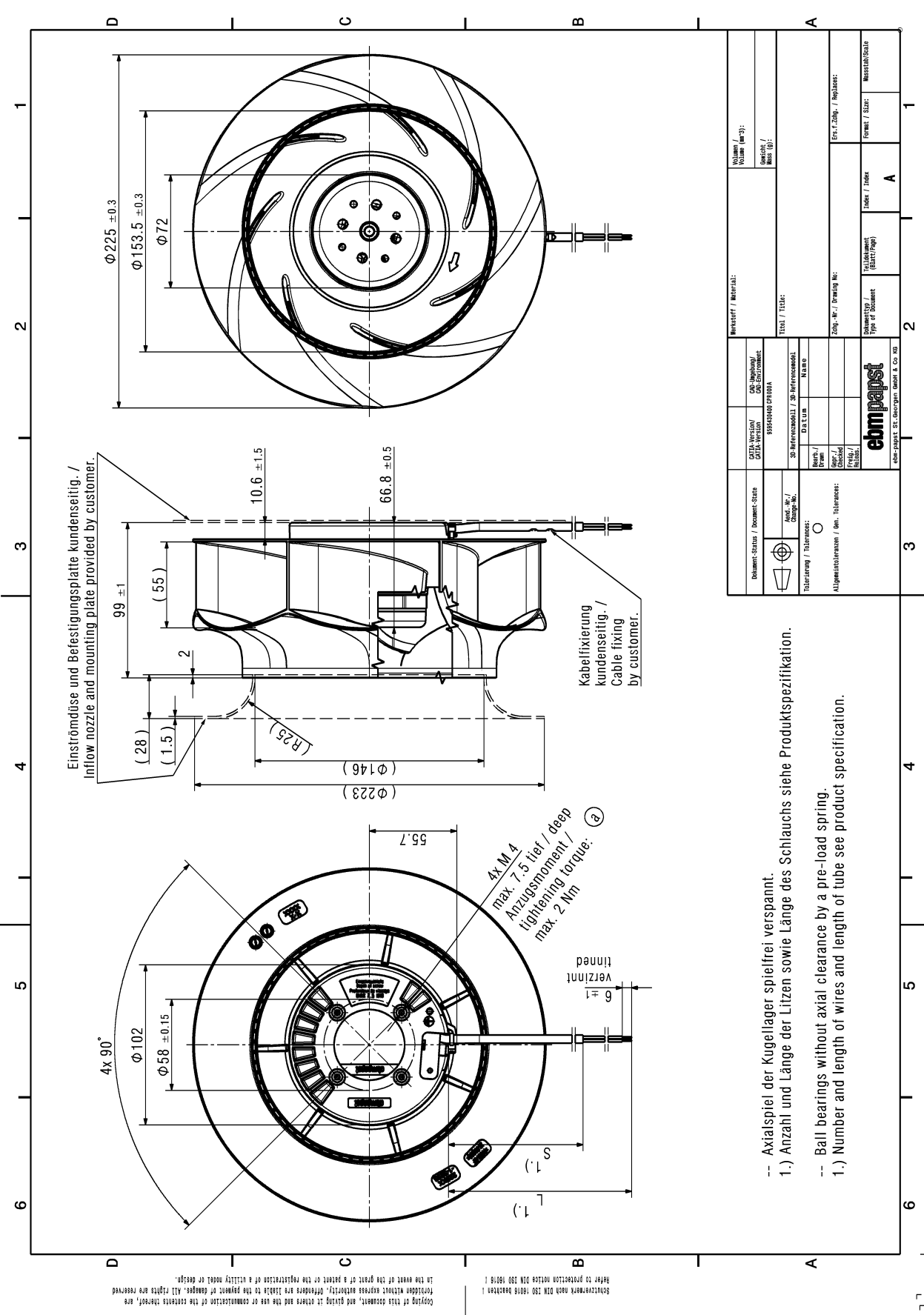

Einströmdüse und Befestigungsplatte kundenseitig. /
Inflow nozzle and mounting plate provided by customer.

Kabelfixierung kundenseitig. /
Cable fixing by customer.

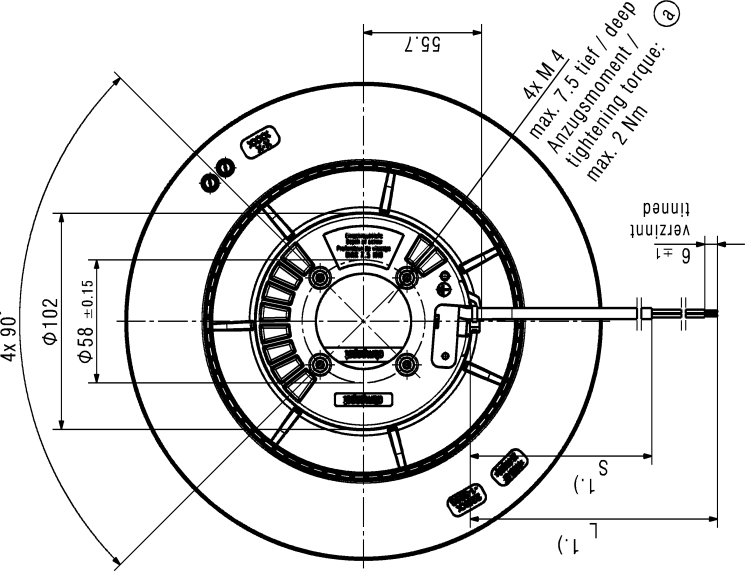

- Axialspiel der Kugellager spielfrei verspannt.
- 1.) Anzahl und Länge der Litzen sowie Länge des Schlauchs siehe Produktspezifikation.
- Ball bearings without axial clearance by a pre-load spring.
- 1.) Number and length of wires and length of tube see product specification.

Document Status / Document-Status Approved / Genehmigt Change No. / Änderungs-Nr.		CAD-Modell / CAD-Environment 85549483 07000A		Inventor / Material:		Volumen / Volume (cm ³): Gewicht / Weight (g): Mass (lb):	
Title / Titel:		Datum / Date:		Zeich.-Nr. / Drawing No.:		Fert.-Zahl. / Revisions:	
Toleranzangabe / Tolerances:		Name / Name:		Dokumenttyp / Document Type:		Formate / Sizes:	
Allgemeine Anmerkungen / General Notes:		ebnmapast		Blatt / Index:		Messmaßstab / Scale:	
0		0		A		A	
3		1		2		1	
4		1		4		1	
5		1		5		1	
6		1		6		1	

Splicing of these components, and giving its address and the use or commissioning of the controls thereof, are
 forbidden without express written consent. Therefore any labels in the present of danger. All rights are reserved
 in the event of the grant of a patent or the registration of a utility model or design.
 SONTWERK nach DIN ISO 9001:2008 zertifiziert /
 SONTWERK nach DIN ISO 9001:2008 certified