

Product Data Sheet 4412F/2GMPR

ebmpapst

The engineer's choice



4412F/2GMPR

INDEX

1	General	3
2	Mechanics	3
2.1	General.....	3
2.2	Connections.....	3
3	Operating Data	4
3.1	Electrical Interface - Input.....	4
3.2	Electrical Operating Data	5
3.3	Electrical Interface - Output.....	6
3.4	Electrical Features	6
3.5	Aerodynamics.....	8
3.6	Sound Data.....	10
4	Environment	10
4.1	General.....	10
4.2	Climatic Requirements	10
5	Safety	12
5.1	Electrical Safety	12
5.2	Approval Tests.....	12
6	Reliability	12
6.1	General.....	12

1 General

Fan type	Fan	
Rotating direction looking at rotor	Counterclockwise - reversible	
Airflow direction	Air outlet over struts	
Bearing system	Sleeve bearing	
Mounting position - shaft	Any	

2 Mechanics

2.1 General

Width	119 mm	
Height	119 mm	
Depth	25,4 mm	
Mass	0,170 kg	
Housing material	Plastic	
Impeller material	Plastic	
Max. torque when mounted across both mounting flanges	Wire outlet corner: 40 Ncm Remaining corners: 10 Ncm	
Screw size	ISO 4762 - M4 degreased, without an additional brace and without washer	

2.2 Connections

Electrical connection	Wires	
Lead wire length	L = 310 mm	
Tolerance	+/- 10 mm	

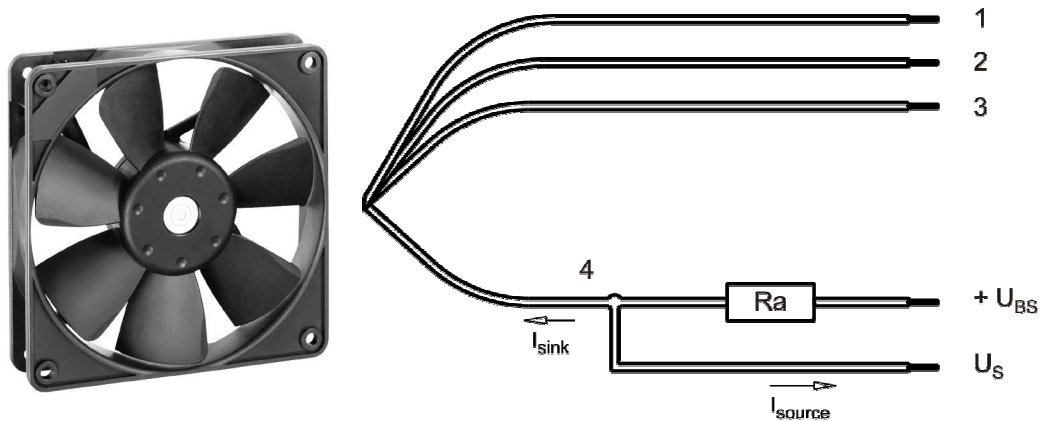

Wire	Color	Operation	Wire size	Insulation diameter
1	red	+ UB	AWG 24	1,55 mm
2	blue	- GND	AWG 24	1,55 mm
3	violet	PWM	AWG 24	1,55 mm
4	white	Tacho	AWG 24	1,55 mm

3 Operating Data

3.1 Electrical Interface - Input

Control input	PWM
---------------	-----

Features

Input type	Open collector	
PWM - Frequency		2 kHz - 5 kHz

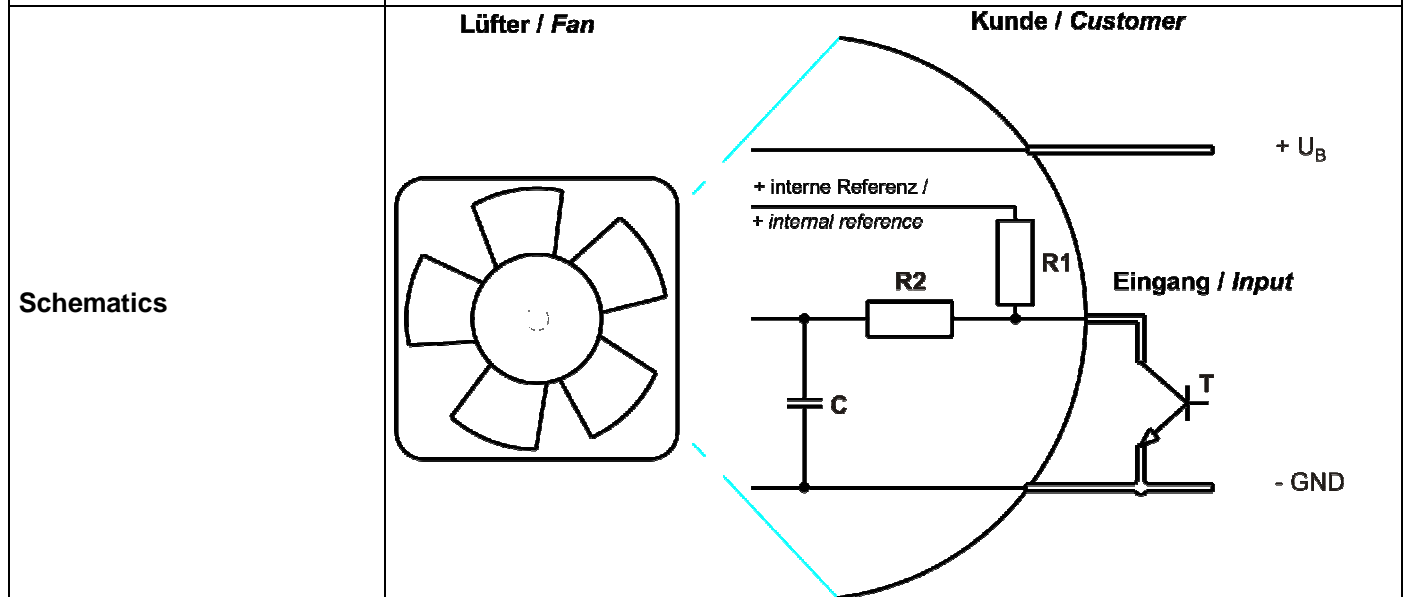
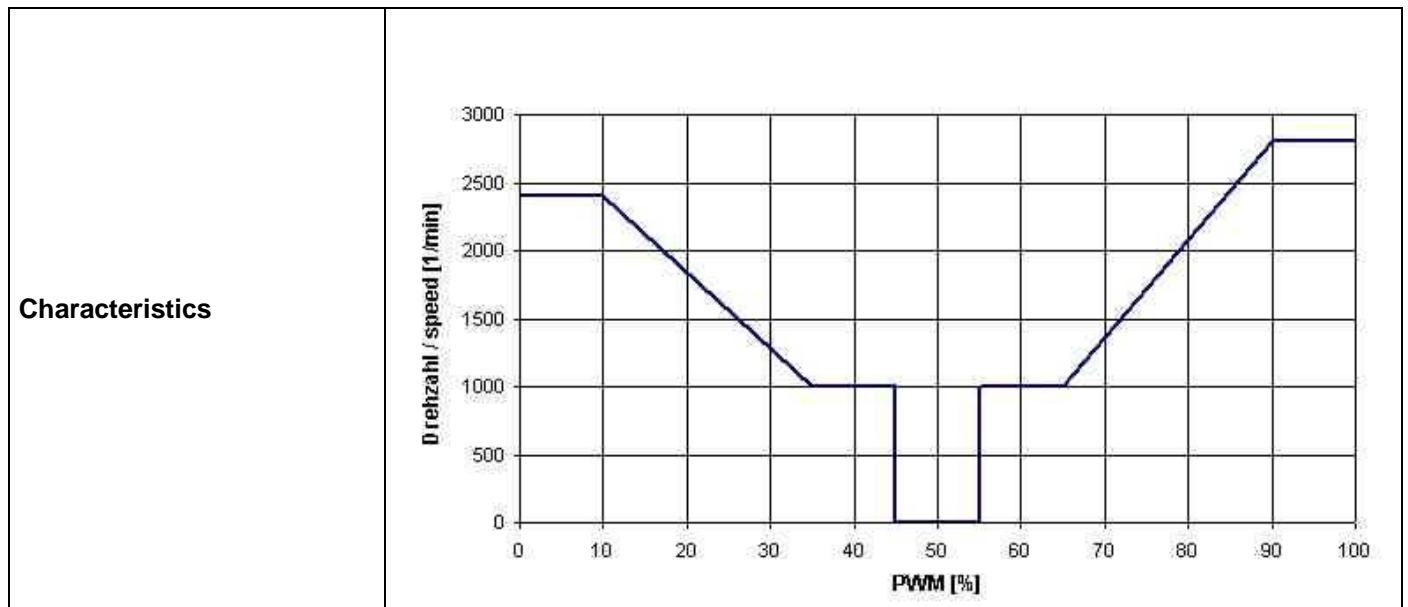

Lüfter mit Drehrichtungsumkehr. 0% - 45% PWM über Stege blasend, 55% - 100% über Stege saugend.

3.2 Electrical Operating Data

Measurement conditions: Normal air density = 1,2 kg/m³; Temperature 23°C +/- 3°C; Motor axis horizontal; warm-up time before measuring 5 minutes (unless otherwise specified). In the intake and outlet area should not be any solid obstruction within 0,5 m.

$\Delta p = 0$: corresp. to free air flow (see chapter aerodynamics)
 I: corresp. to arithm. mean current value

Name	Condition		
PWM 0001	PWM: 0 %;	f: 2 kHz	f: 5 kHz

Rotational direction, looking at Rotor: left (air outlet over struts)

Rotational direction, looking at Rotor: left (air outlet over struts)

Rotational direction, looking at Rotor: right (air intake over struts)

Rotational direction, looking at Rotor: right (air intake over struts)

Features	Condition	Symbol	Values		
Voltage range		U	8,0 V		12,6 V
Nominal voltage		U_N		12,0 V	
Power consumption	$\Delta p = 0$	P	1,7 W	3,4 W	4,1 W
Tolerance	PWM 0010		+/- 25,0 %	+/- 25,0 %	+/- 25,0 %
Current consumption	$\Delta p = 0$	I	208 mA	280 mA	325 mA
Tolerance	PWM 0010		+/- 25,0 %	+/- 25 %	+/- 25,0 %
Speed	$\Delta p = 0$	n	1.700 1/min	2.400 1/min	2.400 1/min
Tolerance	PWM 0010		+/- 7,5 %	+/- 5,0 %	+/- 25,0 %
Starting current consumption				< 800 mA	

**** Vario Pro:** Unless otherwise specified in the table a general fan speed tolerance applies, relating to the maximum value of the required characteristic curve. Tolerance: +/- 5,0 %

3.3 Electrical Interface - Output

Tacho type	/2 (open collector)
------------	---------------------

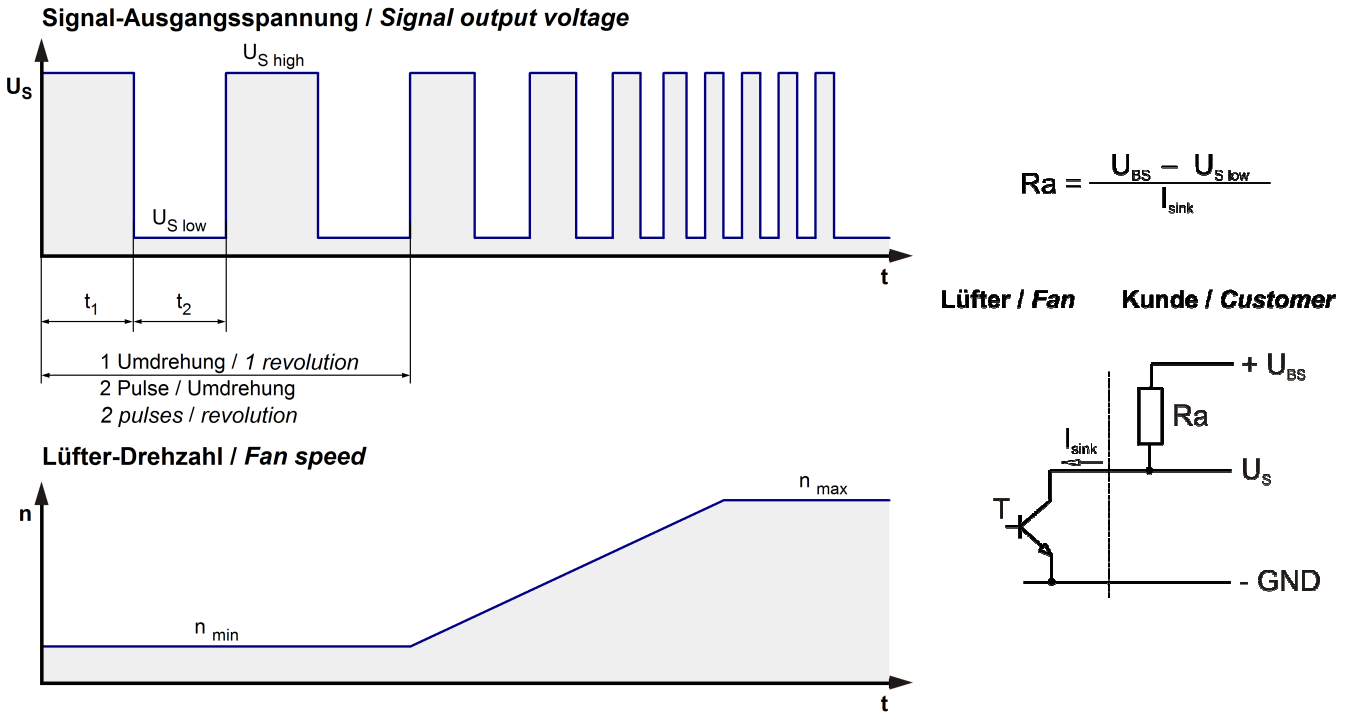

Features	Note	Values
Tacho operating voltage	U_{BS}	$\leq 60\text{ V}$
Tacho signal Low	$U_{S\ low}$	$\leq 0,4\text{ V}$
Tacho signal High	$U_{S\ high}$	$\leq 60\text{ V}$
Maximum sink current	I_{sink}	$\leq 4\text{ mA}$
External resistor	External resistor R_a from U_{BS} to U_S required. All voltages measured to GND.	
Tacho frequency	$(2 \times n) / 60$	
Tacho isolated from motor	No	
Slew rate		$\Rightarrow 0,5\text{ V/us}$

n = revolutions per minute (1/min)

3.4 Electrical Features

Electronic function	Speed-Controlled	
Reversed polarity protection	Rectifying diode	
Max. residual current at U_N	$I_F < 50\text{ uA}$	
Locked rotor protection	Auto restart	
Locked rotor current at U_N	I_{block} approx. 700 mA	
Clock signal at locked rotor	t_3 / t_4 typical: 1,0 s / 10,0 s	

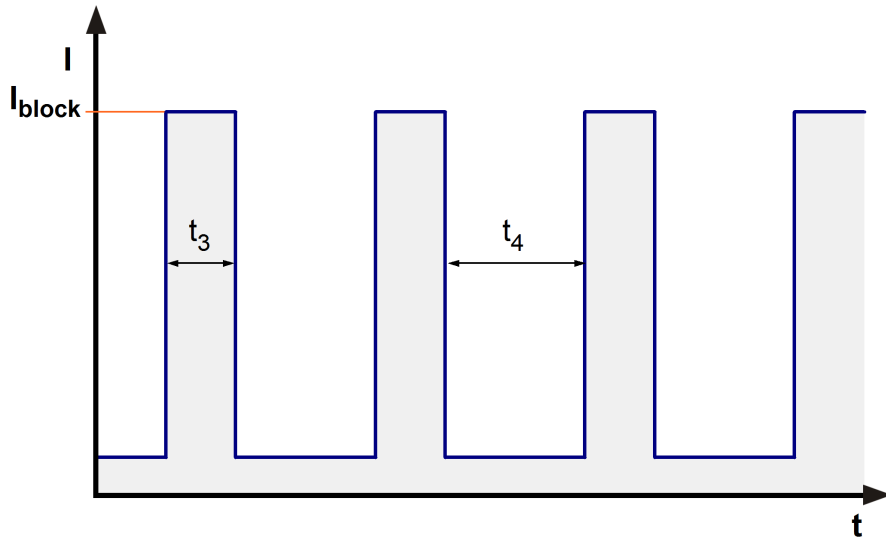

3.5 Aerodynamics

Measurement conditions: Measured with a double chamber intake rig acc. to DIN EN ISO 5801.
 Normal air density = 1,2 kg/m³; Temperature 23°C +/- 3°C;
 In the intake and outlet area should not be any solid obstruction within 0,5 m. Motor shaft horizontal.
 The information is only valid under the specified test conditions and may be changed by the installation conditions. If there are deviations from the standard test conditions, the characteristic values must be checked under the installed conditions.

a.) Operation condition:

2.400 1/min at free air flow	PWM 0 %;	f: 2 kHz	f: 5 kHz
------------------------------	----------	----------	----------

Max. free-air flow ($\Delta p = 0 / \dot{V} = \max.$)	137,0 m ³ /h	
Max. static pressure ($\Delta p = \max. / \dot{V} = 0$)	48 Pa	

Rotation in normal direction.

b.) Operation condition:

2.800 1/min at free air flow	PWM 100 %;	f: 2 kHz	f: 5 kHz
------------------------------	------------	----------	----------

Max. free-air flow ($\Delta p = 0 / \dot{V} = \max.$)	126,0 m ³ /h	
Max. static pressure ($\Delta p = \max. / \dot{V} = 0$)	42 Pa	

Counter rotation.

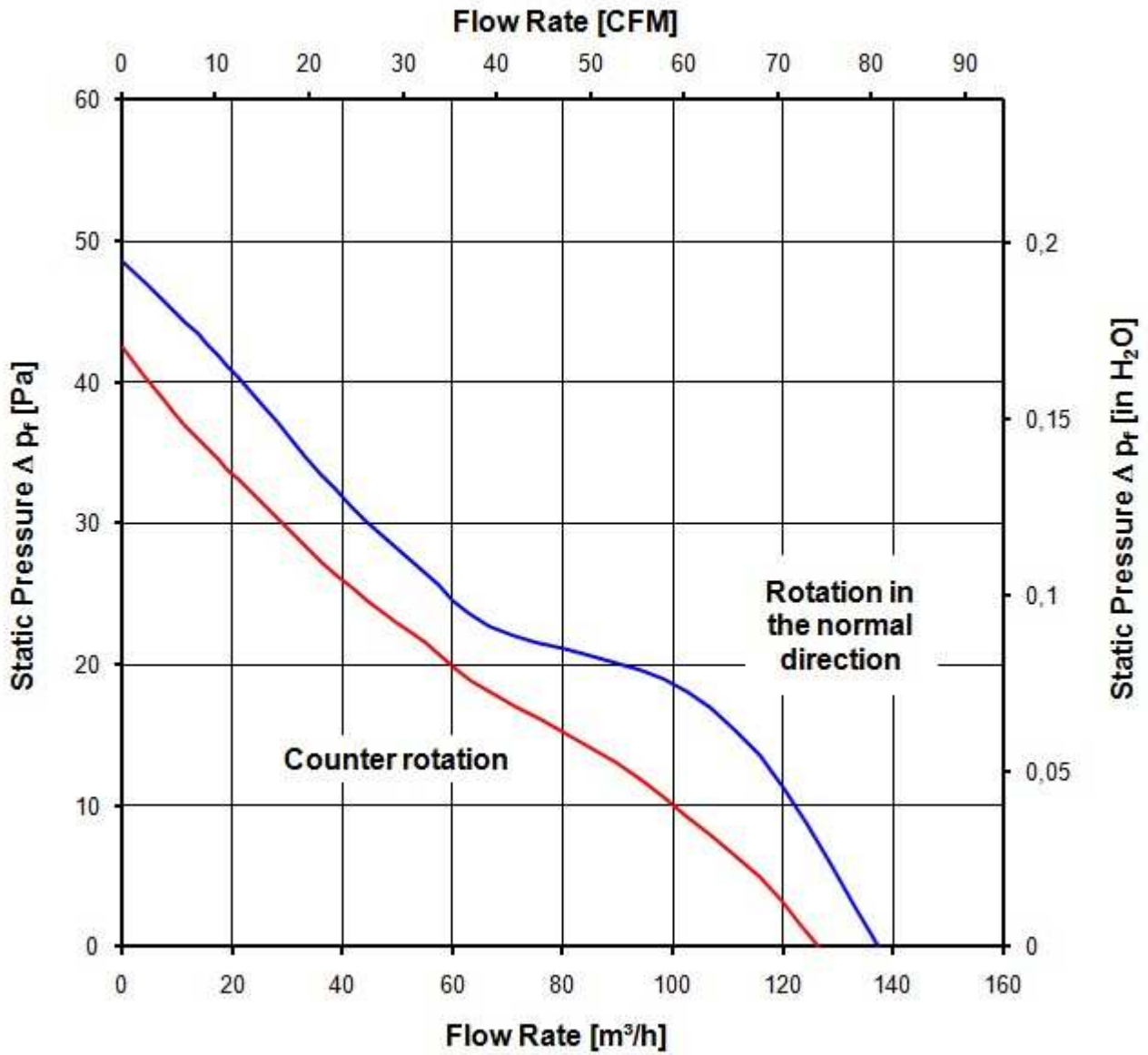

3.6 Sound Data

Measurement conditions: Sound pressure level: 1 meter distance between microphone and the air intake.
 Sound power level: Acc. to DIN 45635 part 38 (ISO 10302) Sound power level: Acc. to DIN 45635 part 38 (ISO 10302)
 Measured in a semianchoic chamber with a background noise level of $L_p(A) < 5 \text{ dB(A)}$
 For further measurement conditions see chapter aerodynamics.

a.) Operation condition:

2.400 1/min at free air flow	PWM 0 %;	f: 2 kHz	f: 5 kHz
------------------------------	----------	----------	----------

Optimal operating point	130,0 m ³ /h @ 13 Pa	
Sound power level at the optimal operating point	4,9 bel(A)	
Sound pressure level at free air flow, measured in rubber bands	37,0 dB(A)	

Rotation in normal direction.

b.) Operation condition:

2.800 1/min at free air flow	PWM 100 %;	f: 2 kHz	f: 5 kHz
------------------------------	------------	----------	----------

Optimal operating point	30,0 m ³ /h @ 25 Pa	
Sound power level at the optimal operating point	5,4 bel(A)	
Sound pressure level at free air flow, measured in rubber bands	49,0 dB(A)	

Counter rotation.

4 Environment

4.1 General

Min. permitted ambient temperature TU min.	-20 °C	
Max. permitted ambient temperature TU max.	70 °C	
Min. permitted storage temperature TL min.	-40 °C	
Max. permitted storage temperature TL max.	80 °C	

4.2 Climatic Requirements

Humidity requirements	humid heat, cyclic; according to DIN EN 60068-2-30, 6 cycle	
Water exposure	None	
Dust requirements	Dust check; according to DIN EN 60068-2-68, 6g/m ² d, 1 day	
Salt fog requirements	None	

Permitted application area:
 The product is for the use in sheltered rooms with limited controlled temperature. Occasionally condensed water is allowed. Direct exposure to water must be avoided. Saline ambient conditions must be avoided.

Pollution degree 2 (according DIN EN 60664-1)

It occurs only non-conductive pollution. Occasionally, temporary conductivity caused by condensation occurs.

Please require severity levels and specification parameters from the responsible development departments.

5 Safety

5.1 Electrical Safety

Dielectric strength DIN EN 60950 (VDE 0805) and DIN EN 60335 (VDE 0700) A.) Type test Measuring conditions: After 48h of storage at 95% R.H. and 25°C. No arcing or breakdown is allowed! All connections together to ground. B.) Routine test Measuring conditions: At indoor climate. No arcing or breakdown is allowed! All connections together to ground.	500 VAC / 1 Min. 850 VDC / 1 Sec.	
Isolation resistance Measuring conditions: After 48h of storage at 95% R.H. and 25°C measured with U=500 VDC for 1 min.	RI > 10 MOhm	
Clearance / creepage distance	1,0 mm / 1,2 mm	
Protection class	III	

5.2 Approval Tests

CE	EC Declaration of Conformity	Yes
EAC	Eurasian Conformity	Yes
UL	Underwriters Laboratories	Yes / UL507, Electric Fans
VDE	Association for Electrical, Electronic and Information Technologies	Yes / Approval acc. to EN 60950 (VDE 0805) - Information technology equipment
CSA	Canadian Standards Association	Yes / C22.2 No. 113 Fans and Ventilators
CCC	China Compulsory Certification	Not applicable

6 Reliability

6.1 General

Copying of this document, and giving it to others and the use or communication of the contents thereof, are forbidden without express authority. Drawings are liable to the payment of damages. All rights are reserved in the event of the grant of a patent or the registration of a utility model or design.

Schutzvermerk nach DIN ISO 16016 beachten/
Refer to protection notice DIN ISO 16016!

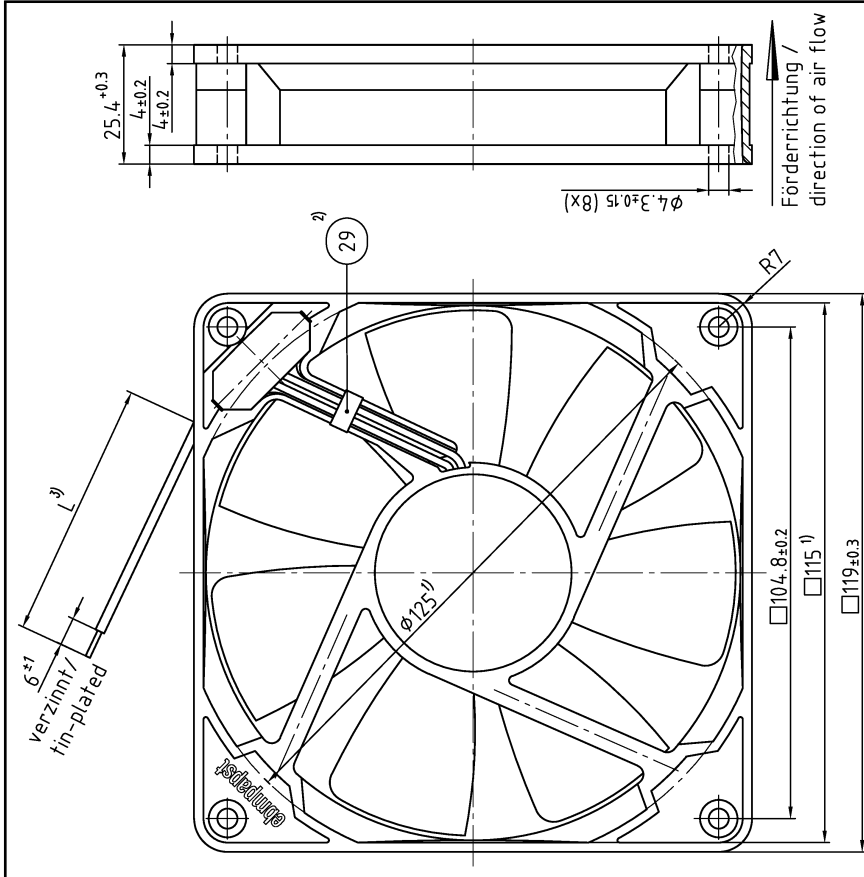

- 1) = Maße für Montagewand / dimensions for assembly wall
- 2) = Pos. 29 nur wenn in Stückliste vorhanden / pos. 29 only if included in bill of material
- 3) = Länge und Anzahl der Litzen siehe Produkt Spezifikation Bl. 3 / length and number of wires see product specification p. 3

SWP-Stab/Side	Änd.-Nr./Change-No.		Werkstoff/Material		Volumen/Volume (mm ³)	Gewicht/Mass (g)
			Aufbau-/System-Nennung CAD-Umgebung/ CAD-Environment	ebmpapst		
Tolerierung/Tolerances:		Datum/Date		Artikel/Title		
Allgemeintoleranzen/Gen. tolerances:		Bezeichnet/ Drawn	Geprüft/ Checked	Zug.-Nr. / Drawing-No.:		
		Empf./ Revised	Feldnummer /No. of Document		Formel/Side	
		ebmpapst St. Georgen GmbH & Co. KG		Mater./Mater.		Maßstab/Scale