

Product Data Sheet DV5218/2HP

ebmpapst

The engineer's choice



DV5218/2HP

INDEX

1	General	3
2	Mechanics	3
2.1	General.....	3
2.2	Connections.....	3
3	Operating Data	4
3.1	Electrical Interface - Input.....	4
3.2	Electrical Operating Data	5
3.3	Electrical Interface - Output.....	6
3.4	Electrical Features	6
3.5	Aerodynamics.....	8
3.6	Sound Data.....	9
4	Environment	9
4.1	General.....	9
4.2	Climatic Requirements	9
5	Safety	10
5.1	Electrical Safety	10
5.2	Approval Tests.....	10
6	Reliability	10
6.1	General.....	10

1 General

Fan type	Mixed-flow fan	
Rotating direction looking at rotor	Counterclockwise	
Airflow direction	Air outlet over struts	
Bearing system	Ball bearing	
Mounting position - shaft	Any	

2 Mechanics

2.1 General

Width	127,0 mm	
Height	127,0 mm	
Depth	38,0 mm	
Mass	0,415 kg	
Housing material	Mixed	
Impeller material	Plastic	
Max. torque when mounted across both mounting flanges	Wire outlet corner: 100 Ncm Remaining corners: 120 Ncm	
Screw size	ISO 4762 - M4 degreased, without an additional brace and without washer	

2.2 Connections

Electrical connection	Wires	
Lead wire length	L = 360 mm	
Tolerance	+ - 10,0 mm	

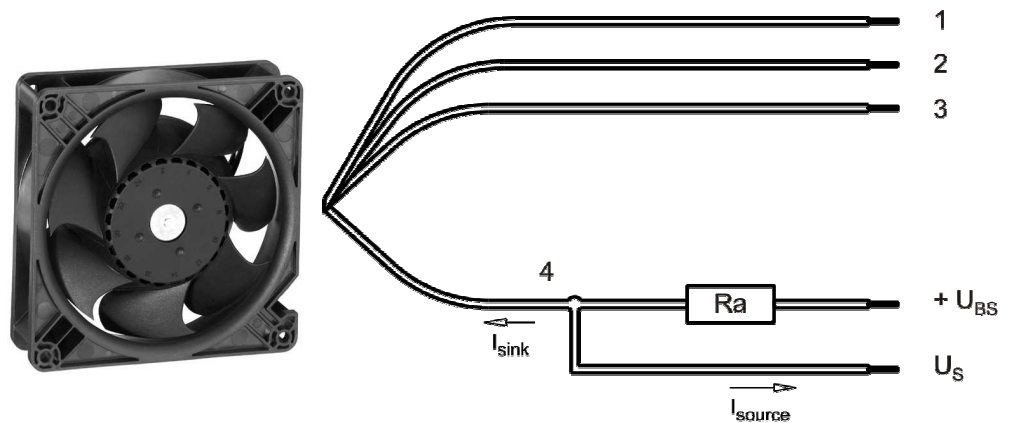

Wire	Color	Operation	Wire size	Insulation diameter
1	red	+ UB	AWG 22	1,70 mm
2	blue	- GND	AWG 22	1,70 mm
3	violet	PWM	AWG 22	1,70 mm
4	white	Tacho	AWG 22	1,70 mm

The auxiliaries shown on the schematic diagram (which are required for the intended use) are not part of our delivery.

3 Operating Data

3.1 Electrical Interface - Input

Control input	PWM
---------------	-----

Features

Inpute type	Open collector
-------------	----------------

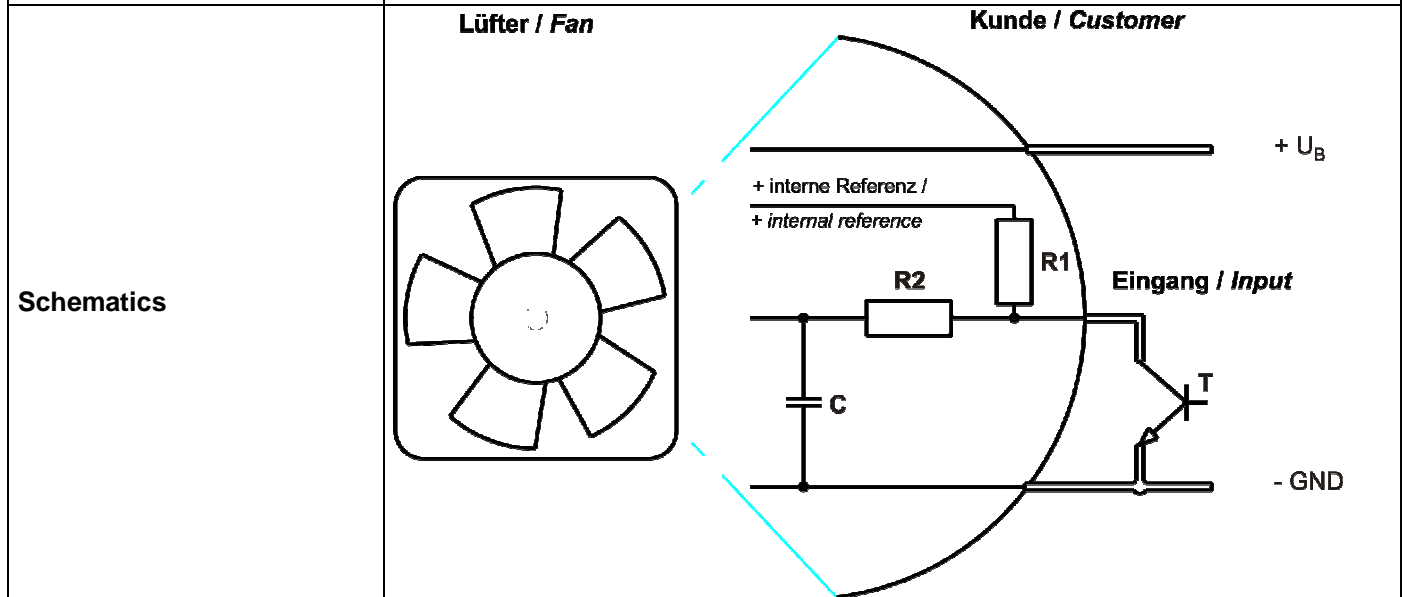
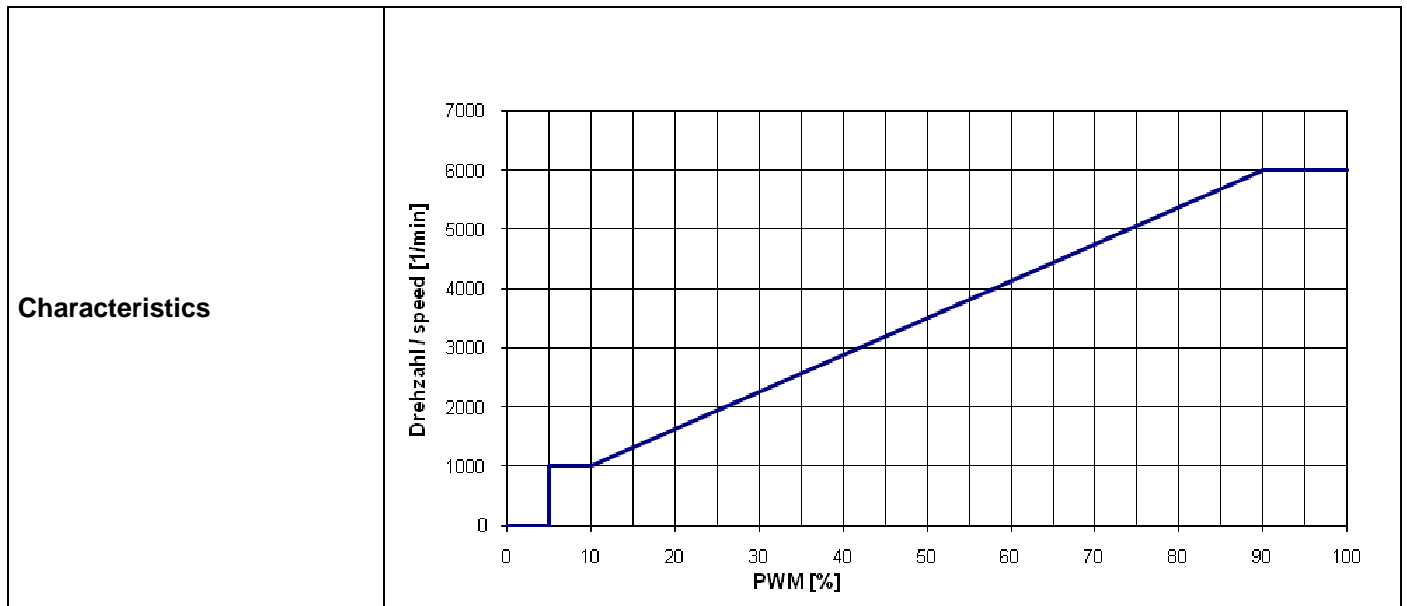

PWM input transistor requirements:
 $U_{CEmax.} \Rightarrow 12\text{ V}$; $I_{Sink\ max.} > 5\text{ mA}$; $U_{CEsat.} < 0,15\text{ V}$

Speed control:

0...100 % PWM; 5 V pull-up, max 2 mA

Without input signal fan is running at maximum Speed.

Internal pullup resistor 4k7 to 5V.

3.2 Electrical Operating Data

Measurement conditions: Normal air density = 1,2 kg/m³; Temperature 23°C +/- 3°C; Motor axis horizontal; warm-up time before measuring 5 minutes (unless otherwise specified). In the intake and outlet area should not be any solid obstruction within 0,5 m.

$\Delta p = 0$: corresp. to free air flow (see chapter aerodynamics)
 I: corresp. to arithm. mean current value

Name	Condition
PWM 0001	PWM: 100 %; f: 2 kHz

Note:

No inrush current at Unom means:

The internal electrolytic capacitor 39uF/100V has no resistor or inrush current limitation, essentially the power supply and the type and length of the connecting cable is limiting the Inrush current.

Features	Condition	Symbol	Values		
Voltage range		U	36 V		60,0 V
Nominal voltage		U _N		48,0 V	
Power consumption	$\Delta p = 0$	P	26,3 W	36,0 W	38,0 W
Tolerance	PWM 0010		+/- 15 %	+/- 15,0 %	+/- 15,0 %
Current consumption	$\Delta p = 0$	I	730 mA	750 mA	635 mA
Tolerance	PWM 0010		+/- 15,0 %	+/- 15,0 %	+/- 15,0 %
Speed	$\Delta p = 0$	n	5.450 1/min	6.000 1/min	6.000 1/min
Tolerance	PWM 0010		+/- 10,0 %	+/- 10,0 %	+/- 10,0 %
Starting current consumption				1.000 mA	

3.3 Electrical Interface - Output

Tacho type	/2 (open collector)
------------	---------------------



Features	Note	Values
Tacho operating voltage	U_{BS}	$\leq 60\text{ V}$
Tacho signal Low	$U_{S\ low}$	$\leq 0,5\text{ V}$
Tacho signal High	$U_{S\ high}$	60 V
Maximum sink current	I_{sink}	$\leq 10\text{ mA}$
External resistor	External resistor R_a from U_{BS} to U_S required. All voltages measured to GND.	
Tacho frequency	$(2 \times n) / 60$	
Tacho isolated from motor	No	
Slew rate		$\Rightarrow 0,5\text{ V/us}$

n = revolutions per minute (1/min)

3.4 Electrical Features

Electronic function	Speed-Controlled	
Reversed polarity protection	Rectifying diode	
Max. residual current at U_N	$I_F \leq 10\text{ mA}$	
Locked rotor protection	Auto restart	
Locked rotor current at U_N	I_{block} approx. 950 mA	
Clock signal at locked rotor	t_3 / t_4 typical: $0,5\text{ s} / 5,0\text{ s}$	

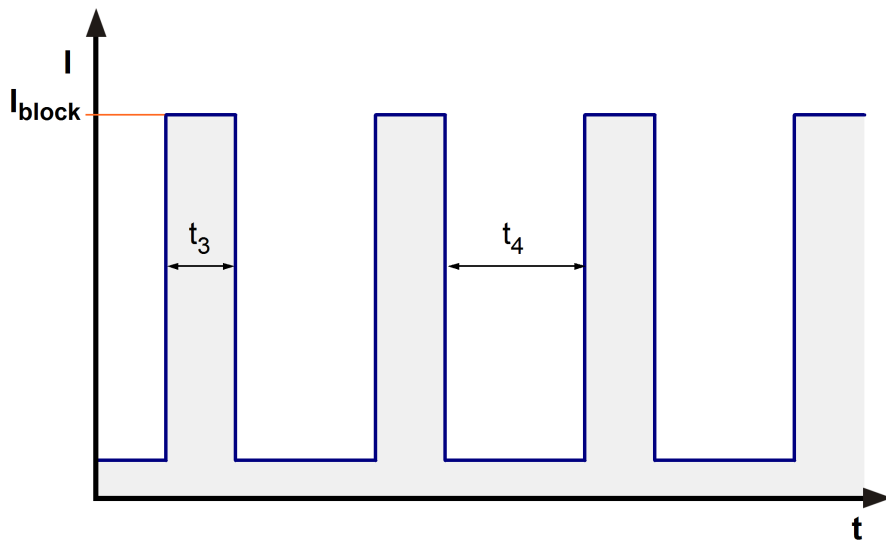
**Internal Fuse:**

Littlefuse NANO2(R) FUSE; Very fast acting 451 Series; 4 A (Art.-Nr.: 451004)

Current during braking of the rotor

Max. current when decelerate at $U_{\text{nom.}} = < 3.000\text{mA}$ peak

3.5 Aerodynamics

Measurement conditions: Measured with a double chamber intake rig acc. to DIN EN ISO 5801.
 Normal air density = 1,2 kg/m³; Temperature 23°C +/- 3°C;
 In the intake and outlet area should not be any solid obstruction within 0,5 m. Motor shaft horizontal.
 The information is only valid under the specified test conditions and may be changed by the installation conditions. If there are deviations from the standard test conditions, the characteristic values must be checked under the installed conditions.

a.) Operation condition:

6.000 1/min at free air flow	PWM 100 %; f: 2 kHz		
------------------------------	---------------------	--	--

Max. free-air flow ($\Delta p = 0 / \dot{V} = \text{max.}$)	320,0 m ³ /h	
Max. static pressure ($\Delta p = \text{max.} / \dot{V} = 0$)	505 Pa	

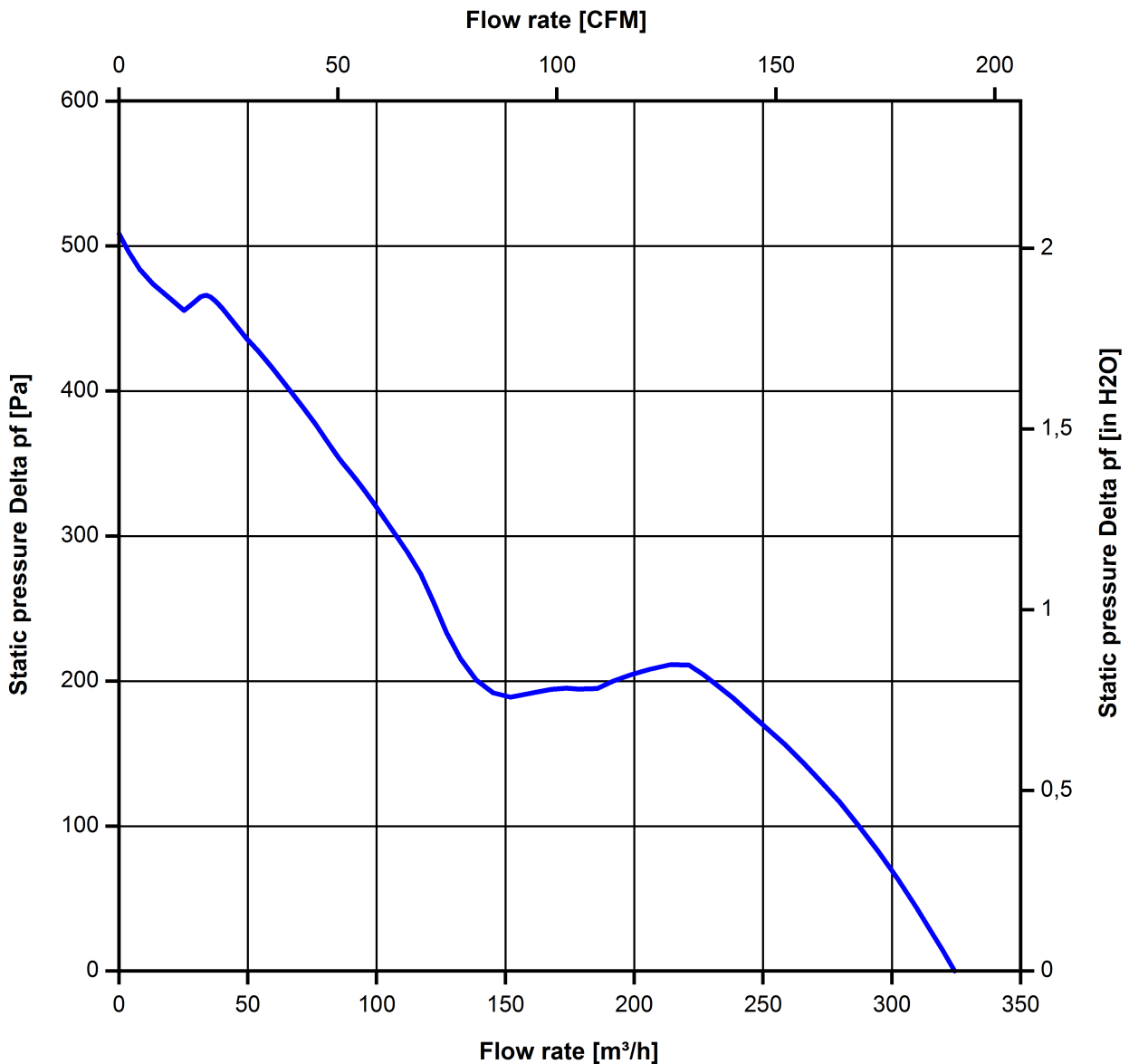

3.6 Sound Data

Measurement conditions: Sound pressure level: 1 meter distance between microphone and the air intake.
 Sound power level: Acc. to DIN 45635 part 38 (ISO 10302)
 Measured in a semianchoic chamber with a background noise level of $L_p(A) < 5 \text{ dB(A)}$
 For further measurement conditions see chapter aerodynamics.

a.) Operation condition:

6.000 1/min at free air flow	PWM 100 %; f: 2 kHz		
Optimal operating point	240,0 m ³ /h @ 145 Pa		
Sound power level at the optimal operating point	7,2 bel(A)		
Sound pressure level at free air flow, measured in rubber bands	62,0 dB(A)		

4 Environment

4.1 General

Min. permitted ambient temperature TU min.	-20 °C	
Max. permitted ambient temperature TU max.	65 °C	
Min. permitted storage temperature TL min.	-40 °C	
Max. permitted storage temperature TL max.	80 °C	

4.2 Climatic Requirements

Humidity requirements	humid heat, constant; according to DIN EN 60068-2-78, 14 days	
Water exposure	None	
Dust requirements	None	
Salt fog requirements	None	

Permitted application area:

The product is intended for use in sheltered rooms with controlled temperature and controlled humidity. Directly exposure to water must be avoided.

Pollution degree 1 (according DIN EN 60664-1)

There is either no pollution or it occurs only dry, non-conductive pollution. The pollution has no negative impact.

Please require severity levels and specification parameters from the responsible development departments.

5 Safety

5.1 Electrical Safety

Dielectric strength DIN EN 60950 (VDE 0805) and DIN EN 60335 (VDE 0700) A.) Type test Measuring conditions: After 48h of storage at 95% R.H. and 25°C. No arcing or breakdown is allowed! All connections together to ground.	500 VAC / 1 Min.	
B.) Routine test Measuring conditions: At indoor climate. No arcing or breakdown is allowed! All connections together to ground.	850 VDC / 1 Sec.	
Isolation resistance Measuring conditions: After 48h of storage at 95% R.H. and 25°C measured with U=500 VDC for 1 min.	RI > 10 MOhm	
Clearance / creepage distance	1,0 mm / 1,2 mm	
Protection class	III	

5.2 Approval Tests

CE	EC Declaration of Conformity	Yes
EAC	Eurasian Conformity	Yes
UL	Underwriters Laboratories	Yes / UL507, Electric Fans
VDE	Association for Electrical, Electronic and Information Technologies	Yes / Approval acc. to EN 60950 (VDE 0805) - Information technology equipment
CSA	Canadian Standards Association	Yes / C22.2 No. 113 Fans and Ventilators
CCC	China Compulsory Certification	Yes / GB 12350 Safety Requirements for small Power Motors

6 Reliability

6.1 General

Life expectancy L10 at TU = 40 °C	62.500 h	
Life expectancy L10 at TU max.	35.000 h	
Life expectancy L10 acc. to IPC 9591 at TU = 40 °C	105.000 h	

Copying of this document, and giving it to others and the use or communication of the contents thereof, are forbidden without express authority. Offenders are liable to the payment of damages. All rights are reserved in the event of the grant of a patent or the registration of a utility model or design.

Schutzmerk nach DIN ISO 16016 beachten!
Refer to protection notice DIN ISO 16016!

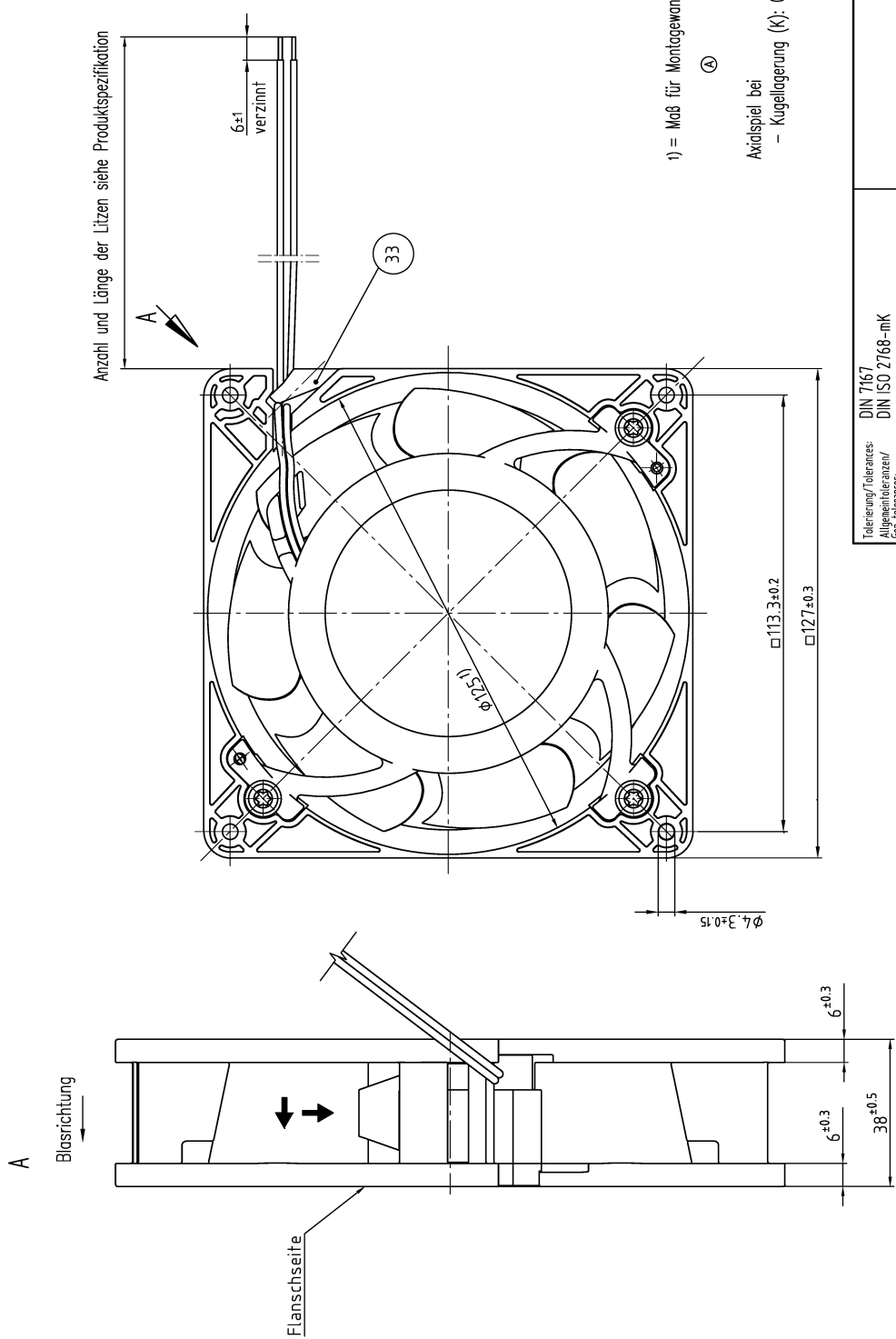

1) = Maß für Montagewand
 Ⓐ
 Axialspiel bei
 – Kugellagerung (K): 0 (mit Federausgleich)

Anzahl und Länge der Litzen siehe Produktspezifikation

Tolerierung/Tolerances: Allgemeintoleranzen/ genl. tolerances		DIN 7167 DIN ISO 2768-mK		Ar./Teil/Title		Messstab/Scale	
Bearb./Draht	Datum/Date	Name/Name		 ebmpapst		Blatt/Page	
		Inser./Inser. / Ersatz-Nr./Change-No.				Ers./Zchg./Replaces:	
Verf. u. zur Verwendung freigegeben/Released for release by				ebmpapst St. Georgen GmbH & Co. KG		A3	